

# SECTION **PWC**

## POWER WINDOW CONTROL SYSTEM

A  
B  
C  
D  
E  
F  
G  
H  
I  
J  
L  
M  
N  
O  
P

### CONTENTS

<p><b>BASIC INSPECTION</b> ..... 4</p> <p><b>DIAGNOSIS AND REPAIR WORK FLOW</b> ..... 4</p> <p style="padding-left: 20px;">Work Flow .....4</p> <p><b>INSPECTION AND ADJUSTMENT</b> ..... 5</p> <p><b>ADDITIONAL SERVICE WHEN REMOVING BATTERY NEGATIVE TERMINAL</b> .....5</p> <p style="padding-left: 20px;">ADDITIONAL SERVICE WHEN REMOVING BATTERY NEGATIVE TERMINAL : Description .....5</p> <p style="padding-left: 20px;">ADDITIONAL SERVICE WHEN REMOVING BATTERY NEGATIVE TERMINAL : Special Repair Requirement .....5</p> <p><b>ADDITIONAL SERVICE WHEN REPLACING CONTROL UNIT</b> .....5</p> <p style="padding-left: 20px;">ADDITIONAL SERVICE WHEN REPLACING CONTROL UNIT : Description .....6</p> <p style="padding-left: 20px;">ADDITIONAL SERVICE WHEN REPLACING CONTROL UNIT : Special Repair Requirement .....6</p> <p><b>SYSTEM DESCRIPTION</b> ..... 7</p> <p><b>POWER WINDOW SYSTEM</b> ..... 7</p> <p style="padding-left: 20px;">System Diagram .....7</p> <p style="padding-left: 20px;">System Description .....7</p> <p style="padding-left: 20px;">Component Parts Location .....9</p> <p style="padding-left: 20px;">Component Description ..... 10</p> <p><b>DIAGNOSIS SYSTEM (BCM)</b> .....11</p> <p><b>COMMON ITEM</b> .....11</p> <p style="padding-left: 20px;">COMMON ITEM : CONSULT Function (BCM - COMMON ITEM) ..... 11</p> <p><b>RETAIND PWR</b> .....12</p> <p style="padding-left: 20px;">RETAIND PWR : CONSULT Function (BCM - RETAINED PWR) ..... 12</p> <p><b>DTC/CIRCUIT DIAGNOSIS</b> .....14</p> <p><b>POWER SUPPLY AND GROUND CIRCUIT</b> .....14</p>	<p><b>BCM</b> .....14</p> <p style="padding-left: 20px;">BCM : Diagnosis Procedure .....14</p> <p><b>POWER WINDOW MAIN SWITCH</b> .....14</p> <p style="padding-left: 20px;">POWER WINDOW MAIN SWITCH : Diagnosis Procedure ..... 14</p> <p><b>POWER WINDOW SUB-SWITCH</b> .....15</p> <p style="padding-left: 20px;">POWER WINDOW SUB-SWITCH : Diagnosis Procedure ..... 15</p> <p><b>POWER WINDOW MOTOR</b> .....17</p> <p><b>DRIVER SIDE</b> .....17</p> <p style="padding-left: 20px;">DRIVER SIDE : Description .....17</p> <p style="padding-left: 20px;">DRIVER SIDE : Component Function Check .....17</p> <p style="padding-left: 20px;">DRIVER SIDE : Diagnosis Procedure .....17</p> <p style="padding-left: 20px;">DRIVER SIDE : Component Inspection ..... 18</p> <p><b>PASSENGER SIDE</b> .....18</p> <p style="padding-left: 20px;">PASSENGER SIDE : Description .....18</p> <p style="padding-left: 20px;">PASSENGER SIDE : Component Function Check .....18</p> <p style="padding-left: 20px;">PASSENGER SIDE : Diagnosis Procedure .....18</p> <p style="padding-left: 20px;">PASSENGER SIDE : Component Inspection .....19</p> <p><b>ENCODER</b> .....21</p> <p><b>DRIVER SIDE</b> .....21</p> <p style="padding-left: 20px;">DRIVER SIDE : Description .....21</p> <p style="padding-left: 20px;">DRIVER SIDE : Component Function Check .....21</p> <p style="padding-left: 20px;">DRIVER SIDE : Diagnosis Procedure .....21</p> <p><b>PASSENGER SIDE</b> .....23</p> <p style="padding-left: 20px;">PASSENGER SIDE : Description .....23</p> <p style="padding-left: 20px;">PASSENGER SIDE : Component Function Check .....23</p> <p style="padding-left: 20px;">PASSENGER SIDE : Diagnosis Procedure .....23</p> <p><b>POWER WINDOW SERIAL LINK</b> .....26</p> <p><b>POWER WINDOW MAIN SWITCH</b> .....26</p> <p style="padding-left: 20px;">POWER WINDOW MAIN SWITCH : Description .....26</p>
---	---



POWER WINDOW MAIN SWITCH : Component Function Check .....	26	<b>WITH BOTH POWER WINDOW MAIN SWITCH AND POWER WINDOW SUB-SWITCH .....</b>	<b>71</b>
POWER WINDOW MAIN SWITCH : Diagnosis Procedure .....	26	WITH BOTH POWER WINDOW MAIN SWITCH AND POWER WINDOW SUB-SWITCH : Descrip- tion .....	71
<b>POWER WINDOW SUB-SWITCH .....</b>	<b>27</b>	WITH BOTH POWER WINDOW MAIN SWITCH AND POWER WINDOW SUB-SWITCH : Diagno- sis Procedure .....	72
POWER WINDOW SUB-SWITCH : Description ....	27	<b>ANTI-PINCH FUNCTION DOES NOT OPER- ATE .....</b>	<b>73</b>
POWER WINDOW SUB-SWITCH : Component Function Check .....	27	<b>DRIVER SIDE .....</b>	<b>73</b>
POWER WINDOW SUB-SWITCH : Diagnosis Procedure .....	28	DRIVER SIDE : Description .....	73
<b>ECU DIAGNOSIS INFORMATION .....</b>	<b>30</b>	DRIVER SIDE : Diagnosis Procedure .....	73
<b>BCM (BODY CONTROL MODULE) .....</b>	<b>30</b>	<b>PASSENGER SIDE .....</b>	<b>73</b>
Reference Value .....	30	PASSENGER SIDE : Description .....	73
Wiring Diagram - BCM - .....	53	PASSENGER SIDE : Diagnosis Procedure .....	73
Fail-safe .....	56	<b>AUTO OPERATION DOES NOT OPERATE BUT MANUAL OPERATES NORMALLY .....</b>	<b>74</b>
DTC Inspection Priority Chart .....	57	<b>DRIVER SIDE .....</b>	<b>74</b>
DTC Index .....	58	DRIVER SIDE : Diagnosis Procedure .....	74
<b>POWER WINDOW MAIN SWITCH .....</b>	<b>61</b>	<b>PASSENGER SIDE .....</b>	<b>74</b>
Reference Value .....	61	PASSENGER SIDE : Diagnosis Procedure .....	74
Wiring Diagram - POWER WINDOW CONTROL SYSTEM - .....	63	<b>POWER WINDOW RETAINED POWER FUNCTION DOES NOT OPERATE NORMAL- LY .....</b>	<b>75</b>
Fail-Safe .....	63	Description .....	75
<b>POWER WINDOW SUB-SWITCH .....</b>	<b>65</b>	Diagnosis Procedure .....	75
Reference Value .....	65	<b>DOOR KEY CYLINDER SWITCH DOES NOT OPERATE POWER WINDOWS .....</b>	<b>76</b>
Wiring Diagram - POWER WINDOW CONTROL SYSTEM - .....	67	Description .....	76
Fail-Safe .....	67	Diagnosis Procedure .....	76
<b>SYMPTOM DIAGNOSIS .....</b>	<b>69</b>	<b>KEYLESS POWER WINDOW DOWN DOES NOT OPERATE .....</b>	<b>77</b>
<b>POWER WINDOWS DO NOT OPERATE WITH ANY POWER WINDOW SWITCHES .....</b>	<b>69</b>	Description .....	77
Description .....	69	Diagnosis Procedure .....	77
Diagnosis Procedure .....	69	<b>POWER WINDOW LOCK SWITCH DOES NOT FUNCTION .....</b>	<b>78</b>
<b>DRIVER SIDE POWER WINDOW ALONE DOES NOT OPERATE .....</b>	<b>70</b>	Diagnosis Procedure .....	78
Description .....	70	<b>POWER WINDOW SWITCH ILLUMINATION DOES NOT ILLUMINATE .....</b>	<b>79</b>
Diagnosis Procedure .....	70	<b>DRIVER SIDE .....</b>	<b>79</b>
<b>PASSENGER SIDE POWER WINDOW ALONE DOES NOT OPERATE .....</b>	<b>71</b>	DRIVER SIDE : Diagnosis Procedure .....	79
<b>WHEN POWER WINDOW MAIN SWITCH IS OP- ERATED .....</b>	<b>71</b>	<b>PASSENGER SIDE .....</b>	<b>79</b>
WHEN POWER WINDOW MAIN SWITCH IS OP- ERATED : Description .....	71	PASSENGER SIDE : Diagnosis Procedure .....	79
WHEN POWER WINDOW MAIN SWITCH IS OP- ERATED : Diagnosis Procedure .....	71	<b>AUTOMATIC WINDOW ADJUSTING FUNC- TION DOES NOT OPERATE .....</b>	<b>80</b>
<b>WHEN POWER WINDOW SUB-SWITCH IS OP- ERATED .....</b>	<b>71</b>	<b>DRIVER SIDE .....</b>	<b>80</b>
WHEN POWER WINDOW SUB-SWITCH IS OP- ERATED : Description .....	71		
WHEN POWER WINDOW SUB-SWITCH IS OP- ERATED : Diagnosis Procedure .....	71		

DRIVER SIDE : Diagnosis Procedure .....80	Precaution for Battery Service .....82	
<b>PASSENGER SIDE .....80</b>	<b>PREPARATION .....83</b>	A
PASSENGER SIDE : Diagnosis Procedure .....80	<b>PREPARATION .....83</b>	B
<b>PRECAUTION .....82</b>	Commercial Service Tools .....83	
<b>PRECAUTIONS .....82</b>	<b>REMOVAL AND INSTALLATION .....84</b>	C
Precaution for Supplemental Restraint System (SRS) "AIR BAG" and "SEAT BELT PRE-TEN- SIONER" .....82	<b>POWER WINDOW MAIN SWITCH .....84</b>	
	Removal and Installation .....84	D

A  
B  
C  
D  
E  
F  
G  
H  
I  
J  
L  
M  
N  
O  
P

**PWC**

# DIAGNOSIS AND REPAIR WORK FLOW

< BASIC INSPECTION >

## BASIC INSPECTION

### DIAGNOSIS AND REPAIR WORK FLOW

Work Flow

INFOID:000000008164953

DETAILED FLOW

#### 1.OBTAIN INFORMATION ABOUT SYMPTOM

Interview the customer to obtain the malfunction information (conditions and environment when the malfunction occurred) as much as possible when the customer brings the vehicle in.

>> GO TO 2.

#### 2.REPRODUCE THE MALFUNCTION INFORMATION

Check the malfunction on the vehicle that the customer describes.  
Inspect the relation of the symptoms and the condition when the symptoms occur.

>> GO TO 3.

#### 3.IDENTIFY THE MALFUNCTIONING SYSTEM WITH "SYMPTOM DIAGNOSIS"

Use "Symptom diagnosis" from the symptom inspection result in step 2 and then identify where to start performing the diagnosis based on possible causes and symptoms.

>> GO TO 4.

#### 4.IDENTIFY THE MALFUNCTIONING PARTS WITH "DTC/CIRCUIT DIAGNOSIS"

Perform the diagnosis with "DTC/CIRCUIT DIAGNOSIS" of the applicable system.

>> GO TO 5.

#### 5.REPAIR OR REPLACE THE MALFUNCTIONING PARTS

Repair or replace the specified malfunctioning parts.

>> GO TO 6.

#### 6.FINAL CHECK

Check that malfunctions are not reproduced when obtaining the malfunction information from the customer, referring to the symptom inspection result in step 2.

Are the malfunctions corrected?

YES >> INSPECTION END

NO >> GO TO 3.

# INSPECTION AND ADJUSTMENT

< BASIC INSPECTION >

## INSPECTION AND ADJUSTMENT

### ADDITIONAL SERVICE WHEN REMOVING BATTERY NEGATIVE TERMINAL

#### ADDITIONAL SERVICE WHEN REMOVING BATTERY NEGATIVE TERMINAL : Description

INFOID:000000008164954

When the battery negative terminal is disconnected, the initialization is necessary.

If any of the following operations are performed, the initialization is necessary as well as when the negative battery terminal is disconnected.

- Power supply to the power window switch or power window motor is cut off by removal of battery terminal or if the battery fuse is blown.
- Disconnection and connection of power window switch harness connector.
- Removal and installation of motor from regulator assembly.
- Operation of regulator assembly as an independent unit.
- Removal and installation of door glass or door glass run.

The following specified operations cannot be performed under the non initialized condition.

- Auto-up operation
- Anti-pinch function
- Key cylinder switch power window function
- Automatic window adjusting function

#### ADDITIONAL SERVICE WHEN REMOVING BATTERY NEGATIVE TERMINAL : Special Repair Requirement

INFOID:000000008164955

#### INITIALIZATION PROCEDURE

1. Disconnect battery negative terminal or power window switch connector. Reconnect it after a minute or more.
2. Door switch is OFF (close).
3. Turn ignition switch ON.
4. Operate power window switch to fully open the window. (This operation is unnecessary if the window is already fully open.)
5. Continue pulling the power window switch AUTO-UP. Even after glass stops at the fully closed position, keep pulling the switch for 3 seconds or more.
6. Initializing procedure is completed.
7. Inspect anti-pinch function.

#### **CAUTION:**

**When initialization is not complete, power window UP does not operate while door is open.**

#### CHECK ANTI-PINCH FUNCTION

1. Fully open the door window.
  2. Place a piece of wood near the fully closed position.
  3. Close door glass completely with AUTO-UP.
- Check that glass lowers for approximately 150 mm (5.9 in) without pinching piece of wood and stops.
  - Check that glass does not rise when operating the power window main switch while lowering.

#### **CAUTION:**

- **Never check with hands and other part of body because they may be pinched. Never get pinched.**
  - **Check that AUTO-UP operates before inspection when system initialization is performed.**
  - **It may switch to fail-safe mode if open/close operation is performed continuously. Perform initial setting in that situation. Refer to [PWC-63. "Fail-Safe"](#)**
  - **Perform initial setting when auto-up operation or anti-pinch function does not operate normally.**
  - **Finish initial setting. Otherwise, next operation cannot be performed.**
1. Auto-up operation
  2. Anti-pinch function
  3. Key cylinder switch power window function
  4. Automatic window adjusting function

#### ADDITIONAL SERVICE WHEN REPLACING CONTROL UNIT

A  
B  
C  
D  
E  
F  
G  
H  
I  
J  
L  
M  
N  
O  
P

PWC

# INSPECTION AND ADJUSTMENT

## < BASIC INSPECTION >

### ADDITIONAL SERVICE WHEN REPLACING CONTROL UNIT : Description

INFOID:000000008164956

When the control unit is replaced, the initialization is necessary.

If any of the following operations are performed, the initialization is necessary and the control unit must be disconnected.

- Power supply to the power window switch or power window motor is cut off by removal of battery terminal or if the battery fuse is blown.
- Disconnection and connection of power window switch harness connector.
- Removal and installation of motor from regulator assembly.
- Operation of regulator assembly as an independent unit.
- Removal and installation of door glass or door glass run.

The following specified operations cannot be performed under the non initialized condition.

- Auto-up operation
- Anti-pinch function
- Key cylinder switch power window function
- Automatic window adjusting function

### ADDITIONAL SERVICE WHEN REPLACING CONTROL UNIT : Special Repair Requirement

INFOID:000000008164957

#### INITIALIZATION PROCEDURE

1. Disconnect battery negative terminal or power window switch connector. Reconnect it after a minute or more.
2. Door switch is OFF (close).
3. Turn ignition switch ON.
4. Operate power window switch to fully open the window. (This operation is unnecessary if the window is already fully open.)
5. Continue pulling the power window switch AUTO-UP. Even after glass stops at the fully closed position, keep pulling the switch for 3 seconds or more.
6. Initializing procedure is completed.
7. Inspect anti-pinch function.

#### **CAUTION:**

**When initialization is not complete, power window UP does not operate while door is open.**

#### CHECK ANTI-PINCH FUNCTION

1. Fully open the door window.
  2. Place a piece of wood near the fully closed position.
  3. Close door glass completely with AUTO-UP.
- Check that glass lowers for approximately 150 mm (5.9 in) without pinching piece of wood and stops.
  - Check that glass does not rise when operating the power window switch while lowering.

#### **CAUTION:**

- **Never check with hands and other part of body because they may be pinched. Never get pinched.**
- **Check that AUTO-UP operates before inspection when system initialization is performed.**
- **It may switch to fail-safe mode if open/close operation is performed continuously. Perform initial setting in that situation. Refer to [PWC-63, "Fail-Safe"](#)**
- **Perform initial setting when auto-up operation or anti-pinch function does not operate normally.**
- **Finish initial setting. Otherwise, next operation cannot be performed.**

1. Auto-up operation
2. Anti-pinch function
3. Key cylinder switch power window function
4. Automatic window adjusting function

# POWER WINDOW SYSTEM

< SYSTEM DESCRIPTION >

## SYSTEM DESCRIPTION

### POWER WINDOW SYSTEM

#### System Diagram

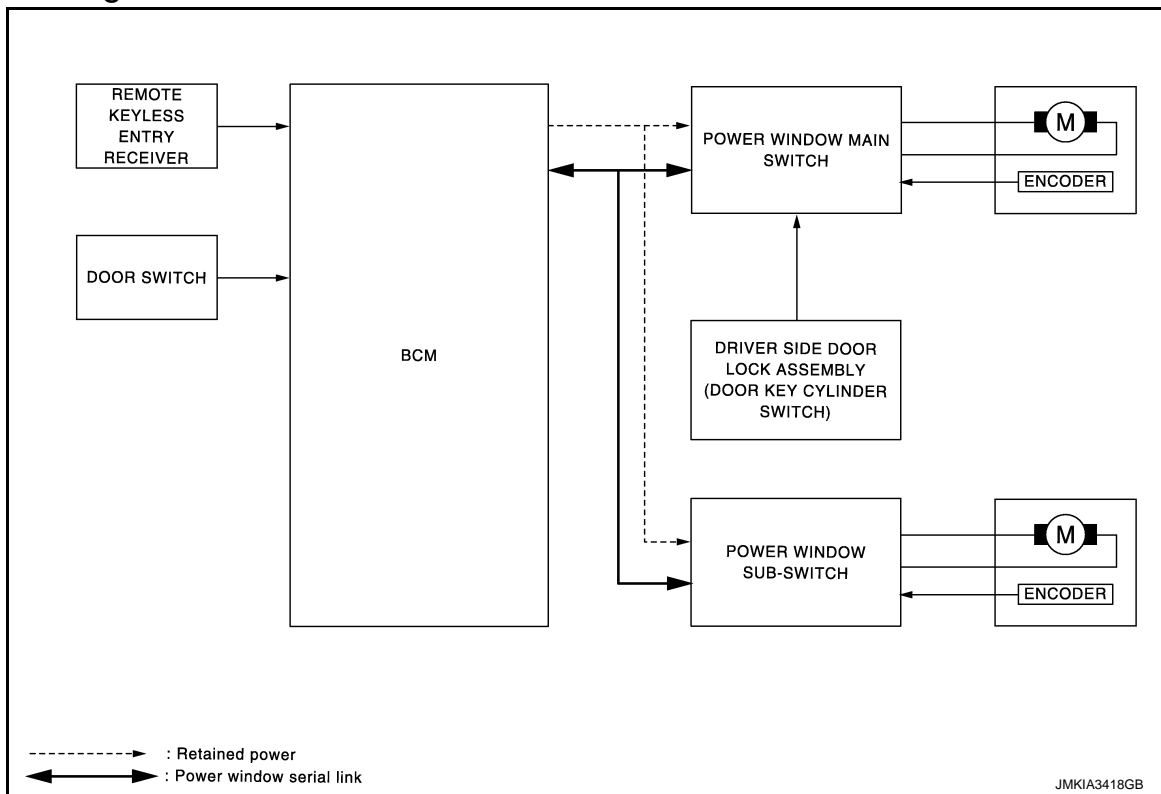

#### System Description

INFOID:000000008164959

#### POWER WINDOW SYSTEM

- Power window system is activated by power window switch operation when ignition switch is turned ON and during the retained power operation, after ignition switch turned OFF.
- Power window main switch can open/close all windows.
- Power window sub-switch can open/close the passenger side windows.
- AUTO operation can be activated by operating the power window switch once.
- It transmits and receives the signal between BCM and power window main switch or power window sub switch, via serial communication.
- When pressing power window lock switch, operation other than power window main switch becomes impossible.
- When detecting the pinching resistance of foreign materials, etc. during power window AUTO UP operation, it lowers door glass to the specified value.
- When opening driver side or passenger side door while door glass is being fully closed, it lowers door glass of the door a little from the closed position. When closing the door, it return door glass to the fully closed position.
- All power windows open or close when Intelligent Key unlock button is pressed for 3seconds.
- Hold the door key cylinder to the LOCK or UNLOCK direction for 1 second or more to OPEN or CLOSE all power windows when ignition switch OFF.

#### POWER WINDOW AUTO-OPERATION

- AUTO UP/DOWN operation can be performed when power window main switch turns to AUTO.
- Encoder continues detecting the movement of power window motor and transmits to power window switch as the encoder pulse signal while power window motor is operating.
- Power window switch reads the changes of encoder signal and stops AUTO operation when door glass is at the fully open/closed position.
- Auto function is inoperable if encoder is malfunctioning.

A  
B  
C  
D  
E  
F  
G  
H  
I  
J  
L  
M  
N  
O  
P

PWC

# POWER WINDOW SYSTEM

## < SYSTEM DESCRIPTION >

---

### POWER WINDOW SERIAL LINK

Power window main switch, power window sub-switch and BCM transmit and receive the signal by power window serial link.

The under mentioned signal is transmitted from BCM to power window main switch.

- Driver side door switch signal.
- Keyless power window down signal.
- Retained power operation signal.

The under mentioned signal is transmitted from BCM to power window sub-switch.

- Passenger side door switch signal.
- Keyless power window down signal.
- Retained power operation signal.

The following signal is transmitted from power window main switch to power window sub-switch.

- Passenger side door window operation signal.
- Power window lock signal.
- Power window control by key cylinder switch signal.

### RETAINED POWER OPERATION

Retained power operation is an additional power supply function that enables power window system to operate for 45 seconds after ignition switch turns OFF.

#### RETAINED POWER FUNCTION CANCEL CONDITIONS

- Front door CLOSED (door switch OFF) → OPEN (door switch ON).
- When ignition switch turns ON again.
- When timer times out. (45 seconds)

### POWER WINDOW LOCK FUNCTION

Ground circuit inside power window main switch shuts off when power window lock switch is ON. This inhibits power window switch operation except with the power window main switch.

### ANTI-PINCH FUNCTION

- The anti-pinch function detects foreign matter being pinched in the door glass, during AUTO-UP operation, and lowers the door glass 150 mm (5.9in).
- Encoder continues detecting the movement of power window motor and transmits to power window switch as the encoder pulse signal while power window motor is operating.
- Resistance is applied to the power window motor rotation that changes the frequency of encoder pulse signal if foreign material is trapped in the door glass.
- Power window switch controls to lower the door glass for 150 mm (5.9in) after it detects encoder pulse signal frequency change.

### OPERATION CONDITION

- When all door glass AUTO-UP operation is performed (anti-pinch function does not operate just before the door glass closes and is fully closed.)

#### **NOTE:**

Depending on environment and driving conditions, if a similar impact or load is applied to the door glass, it may lower.

### AUTOMATIC WINDOW ADJUSTING FUNCTION

When the driver/passenger door(s) is open, the window of the opened door is lowered approximately 10 mm (0.39 in).

When the door is closed, the window is raised to the fully closed position.

Automatic window adjusting function system (opening operation) does not operate when the following item occurs.

- The window is 10 mm (0.39 in) or more open from the fully closed position.

Automatic window adjusting function system (closing operation) does not operate when the following item occurs.

- The automatic window adjusting function system (opening operation) operation.

### DOOR KEY CYLINDER SWITCH POWER WINDOW FUNCTION

Hold the door key cylinder to the LOCK or UNLOCK position for 1 second or more to OPEN or CLOSE all power windows when ignition switch is OFF. In addition, it stops when the key position is NEUTRAL when operating.

#### OPERATION CONDITION

- Ignition switch OFF.
- Hold door key cylinder to the LOCK position for 1 second or more to perform CLOSE operation of the door glass.



# POWER WINDOW SYSTEM

## < SYSTEM DESCRIPTION >

- Hold door key cylinder in the UNLOCK position for 1 second or more to perform OPEN operation of the door glass.

## KEYLESS POWER WINDOW DOWN FUNCTION

All power windows open when the unlock button on Intelligent Key is activated and pressed and held for more than 3\* seconds with the ignition switch OFF. The windows keep opening if the unlock button is continuously pressed.

The power window opening function stops when the following operations are performed.

- When the unlock button is pressed and held for more than 15 seconds.
- When the ignition switch is turned ON while the power window opening is operated.
- When the unlock button is released.

While retained power operation activates, keyless power window down function cannot be operated.

Keyless power window down operation mode can be changed by "PW DOWN SET" mode in "WORK SUPPORT". Refer to [DLK-49. "INTELLIGENT KEY : CONSULT Function \(BCM - INTELLIGENT KEY\)".](#)

### NOTE:

Use CONSULT to change settings.

MODE 1 (3 sec) / MODE 2 (OFF) / MODE 3 (5 sec)

## POWER CONSUMPTION CONTROL SYSTEM

Power window switch incorporates a power consumption control function that reduces the power consumption according to the vehicle status.

### LOW POWER CONSUMPTION MODE

- Ignition switch OFF.
- Power window main switch and power window sub-switch do not receive a signal from serial link.
- Power window motor does not move.

If any of the following conditions are satisfied, the low power consumption mode is released.

- Ignition switch ON.
- When key cylinder switch signal is received.
- When door lock signal is received.
- When the signal is received from serial link.

## Component Parts Location

INFOID:000000008164960

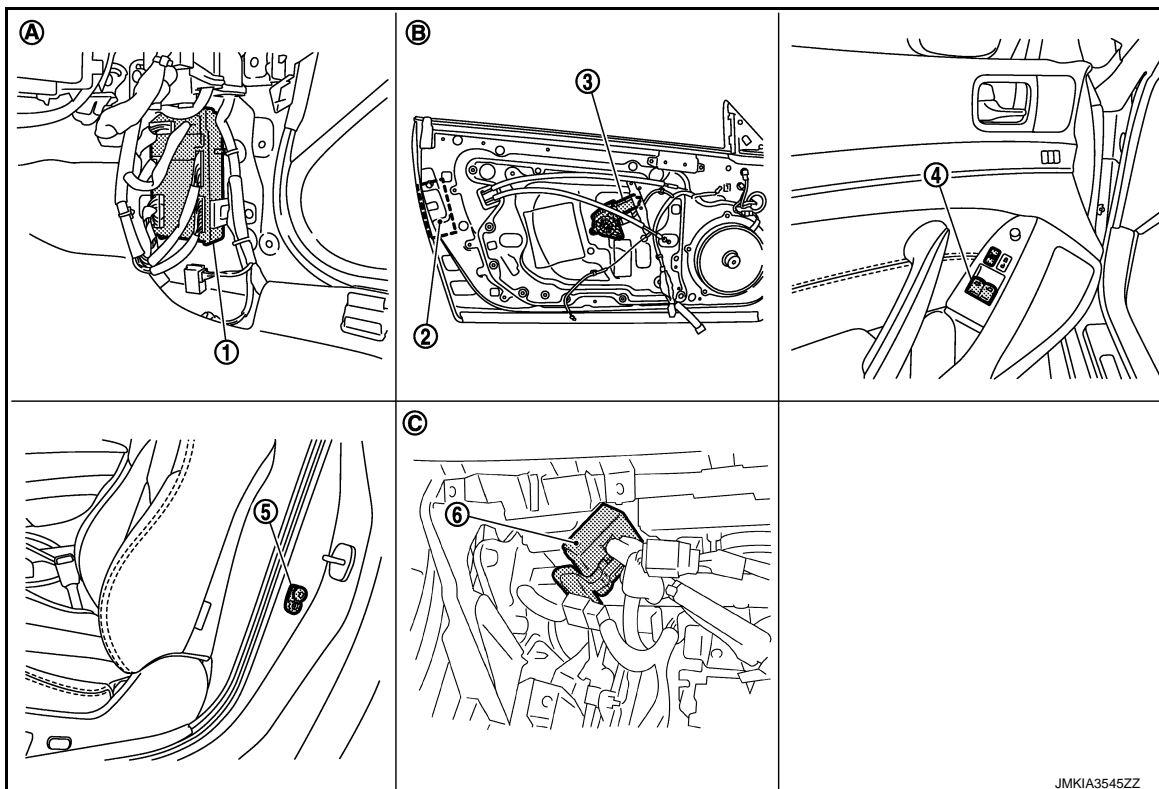

JMKIA3545ZZ

A  
B  
C  
D  
E  
F  
G  
H  
I  
J  
L  
M  
N  
O  
P

PWC

# POWER WINDOW SYSTEM

## < SYSTEM DESCRIPTION >

- |   |  |  |
|---|--|--|
| 1. BCM M118,M119,M122,M123                    | 2. Driver side door lock assembly (door key cylinder switch) D15 | 3. Driver side power window motor D10                        |
| 4. Power window main switch D8                | 5. Driver side door switch B16                                   | 6. Remote keyless entry receiver                             |
| A. View with dash side lower (passenger side) | B. View with door finisher removed                               | C. View with instrument lower panel (passenger side) removed |

## Component Description

INFOID:000000008164961

Component	Function
BCM	<ul style="list-style-type: none"> <li>Supplies power supply to power window switches.</li> <li>Controls retained power.</li> </ul>
Power window main switch	<ul style="list-style-type: none"> <li>Directly controls all power window motor of all doors.</li> <li>Controls anti-pinch operation of power window.</li> </ul>
Power window sub-switch	<ul style="list-style-type: none"> <li>Controls anti-pinch operation of power window.</li> <li>Controls power window motor of passenger door.</li> </ul>
Power window motor	<ul style="list-style-type: none"> <li>Integrates the ENCODER and WINDOW MOTOR.</li> <li>Starts operating with signals from each power window switch.</li> <li>Transmits power window motor rotation as a pulse signal to power window switch.</li> </ul>
Driver side door lock assembly (door key cylinder switch)	Transmits operation condition of key cylinder switch to power window main switch.
Door switch	Detects door open/close condition and transmits to BCM.
Remote keyless entry receiver	Receives lock/unlock signal from the intelligent Key, and then transmits to BCM.

# DIAGNOSIS SYSTEM (BCM)

< SYSTEM DESCRIPTION >

## DIAGNOSIS SYSTEM (BCM)

### COMMON ITEM

### COMMON ITEM : CONSULT Function (BCM - COMMON ITEM)

INFOID:000000008778745

### APPLICATION ITEM

CONSULT performs the following functions via CAN communication with BCM.

Diagnosis mode	Function Description
Work Support	Changes the setting for each system function.
Self Diagnostic Result	Displays the diagnosis results judged by BCM.
CAN Diag Support Monitor	Monitors the reception status of CAN communication viewed from BCM.
Data Monitor	The BCM input/output signals are displayed.
Active Test	The signals used to activate each device are forcibly supplied from BCM.
Ecu Identification	The BCM part number is displayed.
Configuration	This function is not used even though it is displayed.

### SYSTEM APPLICATION

BCM can perform the following functions for each system.

#### NOTE:

It can perform the diagnosis modes except the following for all sub system selection items.

x: Applicable item

System	Sub system selection item	Diagnosis mode		
		Work Support	Data Monitor	Active Test
Door lock	DOOR LOCK	x	x	x
Rear window defogger	REAR DEFOGGER		x	x
Warning chime	BUZZER		x	x
Interior room lamp timer	INT LAMP	x	x	x
Exterior lamp	HEAD LAMP	x	x	x
Wiper and washer	WIPER	x	x	x
Turn signal and hazard warning lamps	FLASHER	x	x	x
—	AIR CONDITONER*			
• Intelligent Key system • Engine start system	INTELLIGENT KEY	x	x	x
Combination switch	COMB SW		x	
Body control system	BCM	x		
IVIS - NATS	IMMU		x	x
Interior room lamp battery saver	BATTERY SAVER	x	x	x
Trunk lid open	TRUNK		x	x
Vehicle security system	THEFT ALM	x	x	x
RAP system	RETAINED PWR		x	
Signal buffer system	SIGNAL BUFFER		x	x
TPMS	AIR PRESSURE MONITOR	x	x	x

#### NOTE:

\*: This item is displayed, but is not used.

### FREEZE FRAME DATA (FFD)

The BCM records the following vehicle condition at the time a particular DTC is detected, and displays on CONSULT.

# DIAGNOSIS SYSTEM (BCM)

## < SYSTEM DESCRIPTION >

CONSULT screen item	Indication/Unit	Description	
Vehicle Speed	km/h	Vehicle speed of the moment a particular DTC is detected	
Odo/Trip Meter	km	Total mileage (Odometer value) of the moment a particular DTC is detected	
Vehicle Condition	SLEEP>LOCK	Power supply position status of the moment a particular DTC is detected	While turning BCM status from low power consumption mode to normal mode (Power supply position is "LOCK"*)
	SLEEP>OFF		While turning BCM status from low power consumption mode to normal mode (Power supply position is "OFF".)
	LOCK>ACC		While turning power supply position from "LOCK"* to "ACC"
	ACC>ON		While turning power supply position from "ACC" to "IGN"
	RUN>ACC		While turning power supply position from "RUN" to "ACC" (Except emergency stop operation)
	CRANK>RUN		While turning power supply position from "CRANKING" to "RUN" (From cranking up the engine to run it)
	RUN>URGENT		While turning power supply position from "RUN" to "ACC" (Emergency stop operation)
	ACC>OFF		While turning power supply position from "ACC" to "OFF"
	OFF>LOCK		While turning power supply position from "OFF" to "LOCK"*
	OFF>ACC		While turning power supply position from "OFF" to "ACC"
	ON>CRANK		While turning power supply position from "IGN" to "CRANKING"
	OFF>SLEEP		While turning BCM status from normal mode (Power supply position is "OFF".) to low power consumption mode
	LOCK>SLEEP		While turning BCM status from normal mode (Power supply position is "LOCK"*. ) to low power consumption mode
	LOCK		Power supply position is "LOCK"*
	OFF		Power supply position is "OFF" (Ignition switch OFF)
	ACC		Power supply position is "ACC" (Ignition switch ACC)
	ON		Power supply position is "IGN" (Ignition switch ON with engine stopped)
	ENGINE RUN		Power supply position is "RUN" (Ignition switch ON with engine running)
CRANKING	Power supply position is "CRANKING" (At engine cranking)		
IGN Counter	0 - 39	The number of times that ignition switch is turned ON after DTC is detected <ul style="list-style-type: none"> <li>• The number is 0 when a malfunction is detected now.</li> <li>• The number increases like 1 → 2 → 3...38 → 39 after returning to the normal condition whenever ignition switch OFF → ON.</li> <li>• The number is fixed to 39 until the self-diagnosis results are erased if it is over 39.</li> </ul>	

### NOTE:

\*: Power supply position shifts to "LOCK" from "OFF", when ignition switch is in the OFF position, selector lever is in the P position (A/T models), and any of the following conditions are met.

- Closing door
- Opening door
- Door is locked using door request switch
- Door is locked using Intelligent Key

The power supply position shifts to "ACC" when the push-button ignition switch (push switch) is pushed at "LOCK".

## RETAIND PWR

### RETAIND PWR : CONSULT Function (BCM - RETAINED PWR)

INFOID:000000008164963

#### Data monitor

### NOTE:

The following table includes information (items) inapplicable to this vehicle. For information (items) applicable to this vehicle, refer to CONSULT display items.

# DIAGNOSIS SYSTEM (BCM)

## < SYSTEM DESCRIPTION >

Monitor Item	Description
DOOR SW-DR	Indicates [ON/OFF] condition of driver side door switch.
DOOR SW-AS	Indicates [ON/OFF] condition of passenger side door switch.

A

B

C

D

E

F

G

H

I

J

PWC

L

M

N

O

P

# POWER SUPPLY AND GROUND CIRCUIT

< DTC/CIRCUIT DIAGNOSIS >

## DTC/CIRCUIT DIAGNOSIS

### POWER SUPPLY AND GROUND CIRCUIT

#### BCM

#### BCM : Diagnosis Procedure

INFOID:000000008164964

#### 1. CHECK FUSE AND FUSIBLE LINK

Check that the following fuse and fusible link are not blown.

Terminal No.	Signal name	Fuse and fusible link No.
1	Battery power supply	K (40A)
11		10 (10A)

#### Is the fuse fusing?

YES >> Replace the blown fuse or fusible link after repairing the affected circuit if a fuse or fusible link is blown.

NO >> GO TO 2.

#### 2. CHECK POWER SUPPLY CIRCUIT

1. Turn ignition switch OFF.
2. Disconnect BCM connectors.
3. Check voltage between BCM harness connector and ground.

(+)		(-)	Voltage (Approx.)
BCM			
Connector	Terminal	Ground	Battery voltage
M118	1		
M119	11		

#### Is the measurement value normal?

YES >> GO TO 3.

NO >> Repair or replace harness.

#### 3. CHECK GROUND CIRCUIT

Check continuity between BCM harness connector and ground.

BCM		Ground	Continuity
Connector	Terminal		
M119	13		Existed

#### Does continuity exist?

YES >> INSPECTION END

NO >> Repair harness or connector.

### POWER WINDOW MAIN SWITCH

#### POWER WINDOW MAIN SWITCH : Diagnosis Procedure

INFOID:000000008164965

#### 1. CHECK POWER SUPPLY CIRCUIT 1

1. Turn ignition switch OFF.
2. Disconnect power window main switch connector.
3. Turn ignition switch ON.
4. Check voltage between power window main switch harness connector and ground.

# POWER SUPPLY AND GROUND CIRCUIT

## < DTC/CIRCUIT DIAGNOSIS >

(+)		(-)	Voltage (V) (Approx.)
Power window main switch			
Connector	Terminal	Ground	Battery voltage
D8	1		
	10		

Is the measurement value within the specification?

YES >> GO TO 3.

NO >> GO TO 2.

### 2.CHECK POWER SUPPLY CIRCUIT 2

1. Turn ignition switch OFF.
2. Disconnect BCM connector.
3. Check continuity between BCM harness connector and power window main switch harness connector.

BCM		Power window main switch		Continuity
Connector	Terminal	Connector	Terminal	
M118	2	D8	1	Existed
	3		10	

4. Check continuity between BCM harness connector and ground.

BCM		Ground	Continuity
Connector	Terminal		
M118	2		Not existed
	3		

Is the inspection result normal?

YES >> Replace BCM. Refer to [BCS-79, "Exploded View"](#)

NO >> Repair or replace harness.

### 3.CHECK GROUND CIRCUIT

1. Turn ignition switch OFF.
2. Check continuity between power window main switch harness connector and ground.

Power window main switch		Ground	Continuity
Connector	Terminal		
D8	15		Existed

Is the inspection result normal?

YES >> INSPECTION END

NO >> Repair or replace harness.

## POWER WINDOW SUB-SWITCH

### POWER WINDOW SUB-SWITCH : Diagnosis Procedure

INFOID:000000008164966

#### 1.CHECK POWER SUPPLY CIRCUIT 1

1. Turn ignition switch OFF.
2. Disconnect power window sub-switch connector.
3. Check voltage between power window sub-switch harness connector and ground.

(+)		(-)	Voltage (V) (Approx.)
Power window sub-switch			
Connector	Terminal	Ground	Battery voltage
D38	10		

# POWER SUPPLY AND GROUND CIRCUIT

< DTC/CIRCUIT DIAGNOSIS >

Is the measurement value within the specification?

YES >> GO TO 3.

NO >> GO TO 2.

## 2. CHECK POWER SUPPLY CIRCUIT 2

1. Turn ignition switch OFF.
2. Disconnect BCM connector.
3. Check continuity between BCM harness connector and power window sub-switch harness connector.

BCM		Power window sub-switch		Continuity
Connector	Terminal	Connector	Terminal	
M118	2	D38	10	Existed

4. Check continuity between BCM harness connector and ground.

BCM		Ground	Continuity
Connector	Terminal		
M118	2		Not existed

Is the inspection result normal?

YES >> Replace BCM. Refer to [BCS-79, "Exploded View"](#)

NO >> Repair or replace harness.

## 3. CHECK GROUND CIRCUIT

Check continuity between power window sub-switch harness connector and ground.

Power window sub-switch		Ground	Continuity
Connector	Terminal		
D38	11		Existed

Is the inspection result normal?

YES >> INSPECTION END

NO >> Repair or replace harness.



# POWER WINDOW MOTOR

< DTC/CIRCUIT DIAGNOSIS >

## POWER WINDOW MOTOR DRIVER SIDE

### DRIVER SIDE : Description

INFOID:000000008164967

Door glass moves UP/DOWN by receiving the signal from power window main switch.

### DRIVER SIDE : Component Function Check

INFOID:000000008164968

#### 1.CHECK POWER WINDOW MOTOR CIRCUIT

Check driver side power window motor operation with power window main switch.

Is the inspection result normal?

YES >> Driver side power window motor is OK.

NO >> Refer to [PWC-17, "DRIVER SIDE : Diagnosis Procedure"](#).

### DRIVER SIDE : Diagnosis Procedure

INFOID:000000008164969

#### 1.CHECK POWER WINDOW MAIN SWITCH OUTPUT SIGNAL

1. Turn ignition switch OFF.
2. Disconnect driver side power window motor connector.
3. Turn ignition switch ON.
4. Check voltage between driver side power window motor harness connector and ground.

(+) Driver side power window motor Connector		Terminal	(-) Ground	Condition	Voltage (V) (Approx.)
Connector	Terminal				
D10	6	Ground	Power window main switch	UP	Battery voltage
				DOWN	0
	3			UP	0
				DOWN	Battery voltage

Is the measurement value within the specification?

YES >> GO TO 2.

NO >> GO TO 3.

#### 2.CHECK POWER WINDOW MOTOR

Check driver side power window motor.

Refer to [PWC-18, "DRIVER SIDE : Component Inspection"](#).

Is the inspection result normal?

YES >> GO TO 4.

NO >> Replace driver side power window motor. Refer to [GW-21, "Removal and Installation"](#).

#### 3.CHECK POWER WINDOW MOTOR CIRCUIT

1. Turn ignition switch OFF.
2. Disconnect power window main switch connector.
3. Check continuity between power window main switch harness connector and driver side power window motor harness connector.

Power window main switch Connector		Driver side power window motor Connector		Continuity
Connector	Terminal	Connector	Terminal	
D8	8	D10	6	Existed
	11		3	

4. Check continuity between power window main switch harness connector and ground.

# POWER WINDOW MOTOR

## < DTC/CIRCUIT DIAGNOSIS >

Power window main switch		Ground	Continuity
Connector	Terminal		
D8	8		Not existed
	11		

Is the inspection result normal?

YES >> Replace power window main switch. Refer to [PWC-84. "Removal and Installation"](#).

NO >> Repair or replace harness.

## 4. CHECK INTERMITTENT INCIDENT

Refer to [GI-43. "Intermittent Incident"](#).

>> INSPECTION END

## DRIVER SIDE : Component Inspection

INFOID:000000008164970

### COMPONENT INSPECTION

#### 1. CHECK DRIVER SIDE POWER WINDOW MOTOR

1. Turn ignition switch OFF.
2. Disconnect driver side power window motor connector.
3. Check motor operation by connecting the battery voltage directly to driver side power window motor connector.

Driver side power window motor connector	Terminal		Motor operation
	(+)	(-)	
D10	3	6	DOWN
	6	3	UP

Is the inspection result normal?

YES >> Driver side power window motor is OK.

NO >> Replace driver side power window motor. Refer to [GW-21. "Removal and Installation"](#).

## PASSENGER SIDE

### PASSENGER SIDE : Description

INFOID:000000008164971

Door glass moves UP/DOWN by receiving the signal power window main switch or power window sub-switch.

### PASSENGER SIDE : Component Function Check

INFOID:000000008164972

#### 1. CHECK POWER WINDOW MOTOR CIRCUIT

Check passenger side power window motor operation with power window main switch or power window sub switch.

Is the inspection result normal?

YES >> Passenger side power window motor is OK.

NO >> Refer to [PWC-18. "PASSENGER SIDE : Diagnosis Procedure"](#).

### PASSENGER SIDE : Diagnosis Procedure

INFOID:000000008164973

#### 1. CHECK POWER WINDOW SUB-SWITCH OUTPUT SIGNAL

1. Turn ignition switch OFF.
2. Disconnect passenger side power window motor connector.
3. Turn ignition switch ON.
4. Check voltage between passenger side power window motor harness connector and ground.

# POWER WINDOW MOTOR

## < DTC/CIRCUIT DIAGNOSIS >

(+)		(-)	Condition	Voltage (V) (Approx.)	
Passenger side power window motor					
Connector	Terminal				
D40	6	Ground	Power window sub-switch	UP	Battery voltage
				DOWN	0
	3			UP	0
				DOWN	Battery voltage

Is the measurement value within the specification?

YES >> GO TO 2.

NO >> GO TO 3.

### 2.CHECK PASSENGER SIDE POWER WINDOW MOTOR

Check passenger side power window motor.

Refer to [PWC-19, "PASSENGER SIDE : Component Inspection"](#).

Is the inspection result normal?

YES >> GO TO 4.

NO >> Replace passenger side power window motor. Refer to [GW-21, "Removal and Installation"](#).

### 3.CHECK POWER WINDOW MOTOR CIRCUIT

1. Turn ignition switch OFF.
2. Disconnect power window sub-switch connector.
3. Check continuity between power window sub-switch harness connector and passenger side power window motor harness connector.

Power window sub-switch		Passenger side power window motor		Continuity
Connector	Terminal	Connector	Terminal	
D38	9	D40	3	Existed
	8		6	

4. Check continuity between power window sub-switch connector and ground.

Power window sub-switch		Ground	Continuity
Connector	Terminal		
D38	8		Not existed
	9		

Is the inspection result normal?

YES >> Replace power window sub-switch. Refer to [PWC-84, "Removal and Installation"](#).

NO >> Repair or replace harness.

### 4.CHECK INTERMITTENT INCIDENT

Refer to [GI-43, "Intermittent Incident"](#).

>> INSPECTION END

## PASSENGER SIDE : Component Inspection

INFOID:000000008164974

### COMPONENT INSPECTION

#### 1.CHECK PASSENGER SIDE POWER WINDOW MOTOR

1. Turn ignition switch OFF.
2. Disconnect passenger side power window motor connector.
3. Check motor operation by connecting the battery voltage directly to passenger side power window motor connector.

# POWER WINDOW MOTOR

## < DTC/CIRCUIT DIAGNOSIS >

Passenger side power window motor connector	Terminal		Motor condition
	(+)	(-)	
D40	3	6	DOWN
	6	3	UP

### Is the inspection result normal?

YES >> Passenger side power window motor is OK.

NO >> Replace passenger side power window motor. Refer to [GW-21, "Removal and Installation"](#).

# ENCODER

< DTC/CIRCUIT DIAGNOSIS >

## ENCODER DRIVER SIDE

### DRIVER SIDE : Description

INFOID:000000008164975

Detects condition of the driver side power window motor operation and transmits to power window main switch as the pulse signal.

### DRIVER SIDE : Component Function Check

INFOID:000000008164976

#### 1.CHECK ENCODER OPERATION

Check that driver side door glass performs AUTO open/close operation normally with power window main switch.

Is the inspection result normal?

YES >> Encoder operation is OK.

NO >> Refer to [PWC-21, "DRIVER SIDE : Diagnosis Procedure"](#).

### DRIVER SIDE : Diagnosis Procedure

INFOID:000000008164977

#### 1.CHECK ENCODER OPERATION

1. Turn ignition switch ON.
2. Check signal between power window main switch harness connector and ground with oscilloscope.

(+)		(-)	Signal (Reference value)
Power window main switch			
Connector	Terminal	Ground	Refer to the following signal
D8	9		
	13		

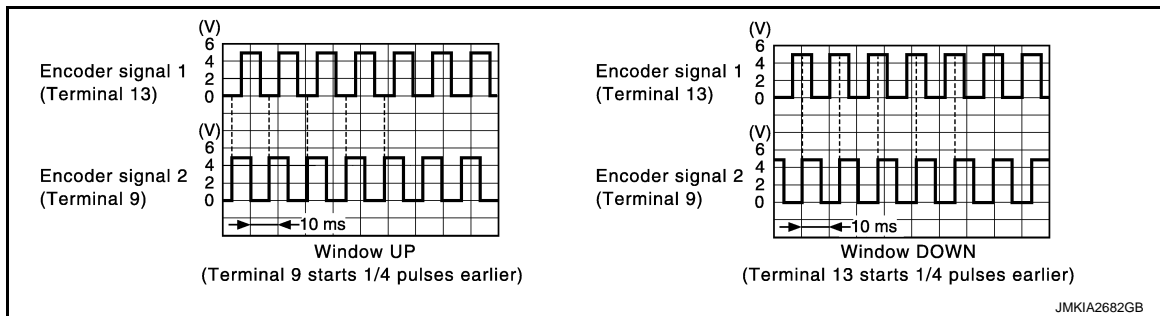

Is the inspection result normal?

YES >> Replace power window main switch. Refer to [PWC-84, "Removal and Installation"](#).

NO >> GO TO 2.

#### 2.CHECK ENCODER SIGNAL CIRCUIT

1. Turn ignition switch OFF.
2. Disconnect power window main switch connector and driver side power window motor connector.
3. Check continuity between power window main switch harness connector and driver side power window motor harness connector.

Power window main switch		Driver side power window motor		Continuity
Connector	Terminal	Connector	Terminal	
D8	9	D10	5	Existed
	13		2	

4. Check continuity between power window main switch harness connector and ground.

# ENCODER

## < DTC/CIRCUIT DIAGNOSIS >

Power window main switch		Ground	Continuity
Connector	Terminal		
D8	9		
	13		Not existed

Is the inspection result normal?

YES >> GO TO 3.

NO >> Repair or replace harness.

### 3.CHECK ENCODER POWER SUPPLY CIRCUIT 1

1. Connect power window main switch connector.
2. Turn ignition switch ON.
3. Check voltage between driver side power window motor harness connector and ground.

(+)		(-)	Voltage (V) (Approx.)
Driver side power window motor			
Connector	Terminal		
D10	4	Ground	Battery voltage

Is the measurement value within the specification?

YES >> GO TO 5.

NO >> GO TO 4.

### 4.CHECK ENCODER POWER SUPPLY CIRCUIT 2

1. Turn ignition switch OFF.
2. Disconnect power window main switch connector.
3. Check continuity between power window main switch harness connector and driver side power window motor harness connector.

Power window main switch		Driver side power window motor		Continuity
Connector	Terminal	Connector	Terminal	
D8	5	D10	4	Existed

4. Check continuity between power window main switch harness connector and ground.

Power window main switch		Ground	Continuity
Connector	Terminal		
D8	5		

Is the inspection result normal?

YES >> Replace power window main switch. Refer to [PWC-84. "Removal and Installation"](#).

NO >> Repair or replace harness.

### 5.CHECK GROUND CIRCUIT 1

1. Turn ignition switch OFF.
2. Disconnect power window main switch connector.
3. Check continuity between power window main switch harness connector and driver side power window motor harness connector.

Power window main switch		Driver side power window motor		Continuity
Connector	Terminal	Connector	Terminal	
D8	14	D10	1	Existed

Is the inspection result normal?

YES >> GO TO 6.

NO >> Repair or replace harness.

### 6.CHECK GROUND CIRCUIT 2

# ENCODER

## < DTC/CIRCUIT DIAGNOSIS >

1. Connect power window main switch connector.
2. Check continuity between power window main switch harness connector and ground.

Power window main switch		Ground	Continuity
Connector	Terminal		
D8	14		Existed

Is the inspection result normal?

YES >> Replace driver side power window motor. Refer to [GW-21, "Removal and Installation"](#).

NO >> Replace power window main switch. Refer to [PWC-84, "Removal and Installation"](#).

## PASSENGER SIDE

### PASSENGER SIDE : Description

INFOID:000000008164978

Detects condition of the passenger side power window motor operation and transmits to power window sub-switch as the pulse signal.

### PASSENGER SIDE : Component Function Check

INFOID:000000008164979

#### 1.CHECK ENCODER OPERATION

Check that passenger side door glass performs AUTO open operation normally with power window main switch or power window sub-switch.

Is the inspection result normal?

YES >> Encoder operation is OK.

NO >> Refer to [PWC-23, "PASSENGER SIDE : Diagnosis Procedure"](#).

### PASSENGER SIDE : Diagnosis Procedure

INFOID:000000008164980

#### 1.CHECK ENCODER SIGNAL

1. Turn ignition switch ON.
2. Check signal between power window sub-switch harness connector and ground with oscilloscope.

(+)		(-)	Signal (Reference value)
Power window sub-switch			
Connector	Terminal		
D38	12	Ground	Refer to the following signal
	15		

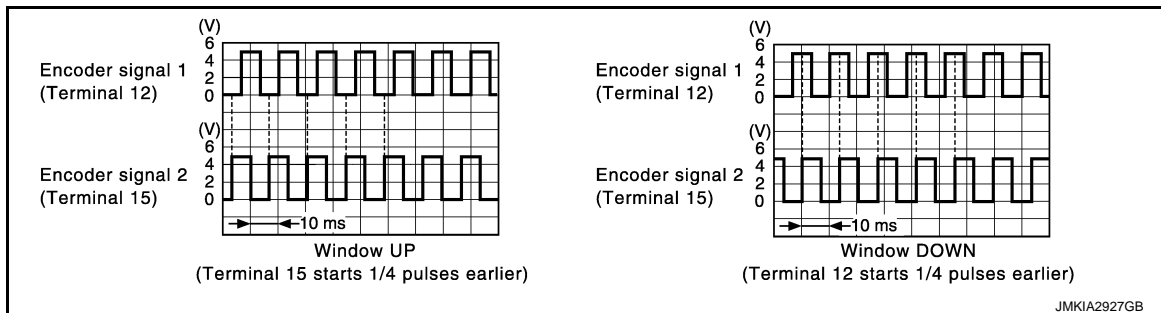

Is the inspection result normal?

YES >> Replace power window sub-switch. Refer to [PWC-84, "Removal and Installation"](#).

NO >> GO TO 2.

#### 2.CHECK ENCODER SIGNAL CIRCUIT

1. Turn ignition switch OFF.
2. Disconnect power window sub-switch connector and passenger side power window motor connector.
3. Check continuity between power window sub-switch harness connector and passenger side power window motor harness connector.

# ENCODER

## < DTC/CIRCUIT DIAGNOSIS >

Power window sub-switch		Passenger side power window motor		Continuity
Connector	Terminal	Connector	Terminal	
D38	12	D40	2	Existed
	15		5	

4. Check continuity between power window sub-switch connector and ground.

Power window sub-switch		Ground	Continuity
Connector	Terminal		
D38	12		Not existed
	15		

Is the inspection result normal?

YES >> GO TO 3.

NO >> Repair or replace harness.

### 3.CHECK ENCODER POWER SUPPLY CIRCUIT 1

1. Connect power window sub-switch connector.
2. Turn ignition switch ON.
3. Check voltage between passenger side power window motor harness connector and ground.

(+)		(-)	Voltage (V) (Approx.)
Passenger side power window motor			
Connector	Terminal		
D40	4	Ground	Battery voltage

Is the measurement value within the specification?

YES >> GO TO 5.

NO >> GO TO 4.

### 4.CHECK ENCODER POWER SUPPLY CIRCUIT 2

1. Turn ignition switch OFF.
2. Disconnect power window sub-switch connector.
3. Check continuity between power window sub-switch harness connector and passenger side power window motor harness connector.

Power window sub-switch		Passenger side power window motor		Continuity
Connector	Terminal	Connector	Terminal	
D38	4	D40	4	Existed

4. Check continuity between power window sub-switch harness connector and ground.

Power window sub-switch		Ground	Continuity
Connector	Terminal		
D38	4		Not existed

Is the inspection result normal?

YES >> Replace power window sub-switch. Refer to [PWC-84, "Removal and Installation"](#).

NO >> Repair or replace harness.

### 5.CHECK GROUND CIRCUIT 1

1. Turn ignition switch OFF.
2. Disconnect power window sub-switch connector.
3. Check continuity between power window sub-switch harness connector and passenger side power window motor harness connector.



# ENCODER

## < DTC/CIRCUIT DIAGNOSIS >

Power window sub-switch		Passenger side power window motor		Continuity
Connector	Terminal	Connector	Terminal	
D38	3	D40	1	Existed

Is the inspection result normal?

YES >> GO TO 6.

NO >> Repair or replace harness.

### 6. CHECK GROUND CIRCUIT 2

1. Connect power window sub-switch connector.
2. Check continuity between power window sub-switch harness connector and ground.

Power window sub-switch		Ground	Continuity
Connector	Terminal		
D38	3		Existed

Is the inspection result normal?

YES >> Replace passenger side power window motor. Refer to [GW-21, "Removal and Installation"](#).

NO >> Replace power window sub-switch. Refer to [PWC-84, "Removal and Installation"](#).

A  
B  
C  
D  
E  
F  
G  
H  
I  
J  
L  
M  
N  
O  
P

PWC

# POWER WINDOW SERIAL LINK

< DTC/CIRCUIT DIAGNOSIS >

## POWER WINDOW SERIAL LINK

### POWER WINDOW MAIN SWITCH

#### POWER WINDOW MAIN SWITCH : Description

INFOID:000000008164981

Power window main switch, power window sub-switch and BCM transmit and receive the signal by power window serial link.

The signal mentioned below is transmitted from BCM to power window main switch, power window sub-switch.

- Keyless power window down signal

The signal mentioned below is transmitted from power window main switch to power window sub-switch.

- Front passenger side door window operation signal
- Power window control by key cylinder switch signal
- Power window lock switch signal
- Retained power operation signal

#### POWER WINDOW MAIN SWITCH : Component Function Check

INFOID:000000008164982

### 1.CHECK POWER WINDOW SWITCH OUTPUT SIGNAL

#### With CONSULT

Check ("CDL LOCK SW", "CDL UNLOCK SW") in "DATA MONITOR" mode for "POWER DOOR LOCK SYSTEM" with CONSULT. Refer to [BCS-16, "COMMON ITEM : CONSULT Function \(BCM - COMMON ITEM\)"](#).

Monitor item	Condition
CDL LOCK SW	LOCK : ON
	UNLOCK : OFF
CDL UNLOCK SW	LOCK : OFF
	UNLOCK : ON

Is the inspection result normal?

YES >> Power window serial link is OK.

NO >> Refer to [PWC-26, "POWER WINDOW MAIN SWITCH : Diagnosis Procedure"](#).

#### POWER WINDOW MAIN SWITCH : Diagnosis Procedure

INFOID:000000008164983

### 1.CHECK POWER WINDOW SWITCH OUTPUT SIGNAL

1. Turn ignition switch ON.
2. Check signal between power window main switch harness connector and ground.

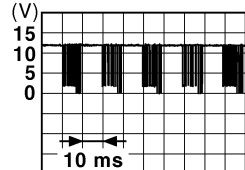
(+) Power window main switch		(-)	Signal (Reference value)
Connector	Terminal		
D8	12	Ground	 <p style="text-align: right;">JPMIA0013GB</p>

Is the inspection result normal?

YES >> GO TO 4.

NO >> GO TO 2.

### 2.CHECK POWER WINDOW SERIAL LINK SIGNAL

1. Turn ignition switch OFF.

# POWER WINDOW SERIAL LINK

## < DTC/CIRCUIT DIAGNOSIS >

2. Disconnect power window main switch connector.
3. Turn ignition switch ON.
4. Check voltage between power window main switch harness connector and ground.

(+)		(-)	Voltage (V) (Approx.)
Power window main switch			
Connector	Terminal	Ground	Battery voltage
D8	12		

Is the inspection result normal?

- YES >> Replace power window main switch. Refer to [PWC-84. "Removal and Installation"](#).  
 NO >> GO TO 3.

### 3.CHECK POWER WINDOW SERIAL LINK CIRCUIT

1. Turn ignition switch OFF.
2. Disconnect BCM connector.
3. Check continuity between BCM connector and power window main switch connector.

BCM		Power window main switch		Continuity
Connector	Terminal	Connector	Terminal	
M123	132	D8	12	Existed

4. Check continuity between BCM connector and ground.

BCM		Ground	Continuity
Connector	Terminal		
M123	132		Not existed

Is the inspection result normal?

- YES >> Replace BCM. Refer to [BCS-79. "Exploded View"](#).  
 NO >> Repair or replace harness.

### 4.CHECK INTERMITTENT INCIDENT

Refer to [GI-43. "Intermittent Incident"](#).

>> INSPECTION END

## POWER WINDOW SUB-SWITCH

### POWER WINDOW SUB-SWITCH : Description

INFOID:000000008164984

Power window main switch, power window sub-switch and BCM transmit and receive the signal by power window serial link.

The signal mentioned below is transmitted from BCM to power window main switch, power window sub-switch.

- Keyless power window down signal

The signal mentioned below is transmitted from power window main switch to power window sub-switch.

- Front passenger side door window operation signal
- Power window control by key cylinder switch signal
- Power window lock switch signal
- Retained power operation signal

### POWER WINDOW SUB-SWITCH : Component Function Check

INFOID:000000008164985

#### 1.CHECK POWER WINDOW SWITCH OUTPUT SIGNAL

##### With CONSULT

Check ("CDL LOCK SW", "CDL UNLOCK SW") in "DATA MONITOR" mode for "POWER DOOR LOCK SYSTEM" with CONSULT. Refer to [BCS-16. "COMMON ITEM : CONSULT Function \(BCM - COMMON ITEM\)"](#).

# POWER WINDOW SERIAL LINK

## < DTC/CIRCUIT DIAGNOSIS >

Monitor item	Condition	
CDL LOCK SW	LOCK	: ON
	UNLOCK	: OFF
CDL UNLOCK SW	LOCK	: OFF
	UNLOCK	: ON

### Is the inspection result normal?

YES >> Power window serial link is OK.

NO >> Refer to [PWC-28. "POWER WINDOW SUB-SWITCH : Diagnosis Procedure"](#).

## POWER WINDOW SUB-SWITCH : Diagnosis Procedure

INFOID:000000008164986

### 1. CHECK POWER WINDOW SWITCH OUTPUT SIGNAL

1. Turn ignition switch ON.
2. Check signal between power window sub-switch harness connector and ground.

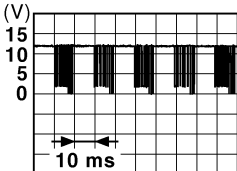
(+)		(-)	Signal (Reference value)
Power window sub-switch			
Connector	Terminal		
D38	16	Ground	 <p style="text-align: right; font-size: small;">JPMA0013GB</p>

### Is the inspection result normal?

YES >> Replace power window sub-switch. Refer to [PWC-84. "Removal and Installation"](#).

NO >> GO TO 2.

### 2. CHECK POWER WINDOW SERIAL LINK SIGNAL

1. Turn ignition switch OFF.
2. Disconnect power window sub-switch connector.
3. Turn ignition switch ON.
4. Check voltage between power window sub-switch harness connector and ground.

(+)		(-)	Voltage (V) (Approx.)
Power window sub-switch			
Connector	Terminal		
D38	16	Ground	Battery voltage

### Is the inspection result normal?

YES >> Replace power window main switch. Refer to [PWC-84. "Removal and Installation"](#).

NO >> GO TO 3.

### 3. CHECK POWER WINDOW SERIAL LINK CIRCUIT

1. Turn ignition switch OFF.
2. Disconnect BCM connector and power window sub-switch connector.
3. Check continuity between BCM connector and power window sub-switch connector.

BCM		Power window sub-switch		Continuity
Connector	Terminal	Connector	Terminal	
M123	132	D38	16	Existed

# POWER WINDOW SERIAL LINK

## < DTC/CIRCUIT DIAGNOSIS >

4. Check continuity between BCM connector and ground.

BCM		Ground	Continuity
Connector	Terminal		
M123	132		Not existed

Is the inspection result normal?

YES >> Replace BCM. Refer to [BCS-79, "Exploded View"](#).

NO >> Repair or replace harness.

A

B

C

D

E

F

G

H

I

J

PWC

L

M

N

O

P

# BCM (BODY CONTROL MODULE)

< ECU DIAGNOSIS INFORMATION >

## ECU DIAGNOSIS INFORMATION

### BCM (BODY CONTROL MODULE)

#### Reference Value

INFOID:000000008778746

#### VALUES ON THE DIAGNOSIS TOOL

##### NOTE:

The following table includes information (items) inapplicable to this vehicle. For information (items) applicable to this vehicle, refer to CONSULT display items.

##### CONSULT MONITOR ITEM

Monitor Item	Condition	Value/Status
FR WIPER HI	Other than front wiper switch HI	Off
	Front wiper switch HI	On
FR WIPER LOW	Other than front wiper switch LO	Off
	Front wiper switch LO	On
FR WASHER SW	Front washer switch OFF	Off
	Front washer switch ON	On
FR WIPER INT	Other than front wiper switch INT/AUTO	Off
	Front wiper switch INT/AUTO	On
FR WIPER STOP	Front wiper is not in STOP position	Off
	Front wiper is in STOP position	On
INT VOLUME	Wiper volume dial is in a dial position 1 - 7	Wiper volume dial position
TURN SIGNAL R	Other than turn signal switch RH	Off
	Turn signal switch RH	On
TURN SIGNAL L	Other than turn signal switch LH	Off
	Turn signal switch LH	On
TAIL LAMP SW	Other than lighting switch 1ST and 2ND	Off
	Lighting switch 1ST or 2ND	On
HI BEAM SW	Other than lighting switch HI	Off
	Lighting switch HI	On
HEAD LAMP SW 1	Other than lighting switch 2ND	Off
	Lighting switch 2ND	On
HEAD LAMP SW 2	Other than lighting switch 2ND	Off
	Lighting switch 2ND	On
PASSING SW	Other than lighting switch PASS	Off
	Lighting switch PASS	On
AUTO LIGHT SW	Other than lighting switch AUTO	Off
	Lighting switch AUTO	On
FR FOG SW	Front fog lamp switch OFF	Off
	Front fog lamp switch ON	On
RR FOG SW	<b>NOTE:</b> The item is indicated, but not monitored.	Off
DOOR SW-DR	Driver door closed	Off
	Driver door opened	On
DOOR SW-AS	Passenger door closed	Off
	Passenger door opened	On

## BCM (BODY CONTROL MODULE)

### < ECU DIAGNOSIS INFORMATION >

Monitor Item	Condition	Value/Status
DOOR SW-RR	<b>NOTE:</b> The item is indicated, but not monitored.	Off
DOOR SW-RL	<b>NOTE:</b> The item is indicated, but not monitored.	Off
DOOR SW-BK	<b>NOTE:</b> The item is indicated, but not monitored.	Off
CDL LOCK SW	Other than power door lock switch LOCK	Off
	Power door lock switch LOCK	On
CDL UNLOCK SW	Other than power door lock switch UNLOCK	Off
	Power door lock switch UNLOCK	On
KEY CYL LK-SW	Other than driver door key cylinder LOCK position	Off
	Driver door key cylinder LOCK position	On
KEY CYL UN-SW	Other than driver door key cylinder UNLOCK position	Off
	Driver door key cylinder UNLOCK position	On
KEY CYL SW-TR	<b>NOTE:</b> The item is indicated, but not monitored.	Off
HAZARD SW	Hazard switch is OFF	Off
	Hazard switch is ON	On
REAR DEF SW	<b>NOTE:</b> The item is indicated, but not monitored.	Off
TR CANCEL SW	Trunk lid opener cancel switch OFF	Off
	Trunk lid opener cancel switch ON	On
TR/BD OPEN SW	Trunk lid opener switch OFF	Off
	While the trunk lid opener switch is turned ON	On
TRNK/HAT MNTR	Trunk lid closed	Off
	Trunk lid opened	On
REVERSE SW	<b>NOTE:</b> The item is indicated, but not monitored.	Off
RKE-LOCK	LOCK button of the Intelligent Key is not pressed	Off
	LOCK button of the Intelligent Key is pressed	On
RKE-UNLOCK	UNLOCK button of the Intelligent Key is not pressed	Off
	UNLOCK button of the Intelligent Key is pressed	On
RKE-TR/BD	TRUNK OPEN button of the Intelligent Key is not pressed	Off
	TRUNK OPEN button of the Intelligent Key is pressed	On
RKE-PANIC	PANIC button of the Intelligent Key is not pressed	Off
	PANIC button of the Intelligent Key is pressed	On
RKE-P/W OPEN	UNLOCK button of the Intelligent Key is not pressed	Off
	UNLOCK button of the Intelligent Key is pressed and held	On
RKE-MODE CHG	LOCK/UNLOCK button of the Intelligent Key is not pressed and held simultaneously	Off
	LOCK/UNLOCK button of the Intelligent Key is pressed and held simultaneously	On
OPTICAL SENSOR	Bright outside of the vehicle	Close to 5 V
	Dark outside of the vehicle	Close to 0 V
REQ SW -DR	Driver door request switch is not pressed	Off
	Driver door request switch is pressed	On
REQ SW -AS	Passenger door request switch is not pressed	Off
	Passenger door request switch is pressed	On

A

B

C

D

E

F

G

H

I

J

PWC

L

M

N

O

P

## BCM (BODY CONTROL MODULE)

### < ECU DIAGNOSIS INFORMATION >

Monitor Item	Condition	Value/Status
REQ SW -RR	<b>NOTE:</b> The item is indicated, but not monitored.	Off
REQ SW -RL	<b>NOTE:</b> The item is indicated, but not monitored.	Off
REQ SW -BD/TR	Trunk lid opener request switch is not pressed	Off
	Trunk lid opener request switch is pressed	On
PUSH SW	Push-button ignition switch (push switch) is not pressed	Off
	Push-button ignition switch (push switch) is pressed	On
IGN RLY2 -F/B	<b>NOTE:</b> The item is indicated, but not monitored.	Off
ACC RLY -F/B	<b>NOTE:</b> The item is indicated, but not monitored.	Off
CLUCH SW	The clutch pedal is not depressed	Off
	The clutch pedal is depressed	On
BRAKE SW 1	The brake pedal is depressed when No. 7 fuse is blown	Off
	The brake pedal is not depressed when No. 7 fuse is blown, or No. 7 fuse is normal	On
BRAKE SW 2	The brake pedal is not depressed	Off
	The brake pedal is depressed	On
DETE/CANCL SW	<ul style="list-style-type: none"> <li>• Selector lever in P position (Except M/T models)</li> <li>• The clutch pedal is depressed (M/T models)</li> </ul>	Off
	<ul style="list-style-type: none"> <li>• Selector lever in any position other than P (Except M/T models)</li> <li>• The clutch pedal is not depressed (M/T models)</li> </ul>	On
SFT PN/N SW	Selector lever in any position other than P and N	Off
	Selector lever in P or N position	On
S/L -LOCK	<b>NOTE:</b> The item is indicated, but not monitored.	Off
S/L -UNLOCK	<b>NOTE:</b> The item is indicated, but not monitored.	Off
S/L RELAY-F/B	<b>NOTE:</b> The item is indicated, but not monitored.	Off
UNLK SEN -DR	Driver door is unlocked	Off
	Driver door is locked	On
PUSH SW -IPDM	Push-button ignition switch (push-switch) is not pressed	Off
	Push-button ignition switch (push-switch) is pressed	On
IGN RLY1 -F/B	Ignition switch in OFF or ACC position	Off
	Ignition switch in ON position	On
DETE SW -IPDM	Selector lever in any position other than P	Off
	Selector lever in P position	On
SFT PN -IPDM	<ul style="list-style-type: none"> <li>• Selector lever in any position other than P and N (Except M/T models)</li> <li>• The clutch pedal is not depressed (M/T models)</li> </ul>	Off
	<ul style="list-style-type: none"> <li>• Selector lever in P or N position</li> <li>• The clutch pedal is depressed</li> </ul>	On
SFT P -MET	Selector lever in any position other than P	Off
	Selector lever in P position	On
SFT N -MET	Selector lever in any position other than N	Off
	Selector lever in N position	On



## BCM (BODY CONTROL MODULE)

### < ECU DIAGNOSIS INFORMATION >

Monitor Item	Condition	Value/Status	
ENGINE STATE	Engine stopped	Stop	A
	While the engine stalls	Stall	
	At engine cranking	Crank	B
	Engine running	Run	
S/L LOCK-IPDM	<b>NOTE:</b> The item is indicated, but not monitored.	Off	C
S/L UNLK-IPDM	<b>NOTE:</b> The item is indicated, but not monitored.	Off	
S/L RELAY-REQ	<b>NOTE:</b> The item is indicated, but not monitored.	Off	D
VEH SPEED 1	While driving	Equivalent to speedometer reading	E
VEH SPEED 2	While driving	Equivalent to speedometer reading	
DOOR STAT-DR	Driver door is locked	LOCK	F
	Wait with selective UNLOCK operation (60 seconds)	READY	
	Driver door is unlocked	UNLOCK	G
DOOR STAT-AS	Passenger door is locked	LOCK	
	Wait with selective UNLOCK operation (60 seconds)	READY	H
	Passenger door is unlocked	UNLOCK	
ID OK FLAG	Driver side door is open after ignition switch is turned OFF (Selector lever is in the P position except for M/T models)	Reset	I
	Ignition switch is ON	Set	
PRMT ENG STRT	The engine start is prohibited	Reset	J
	The engine start is permitted	Set	
PRMT RKE STRT	<b>NOTE:</b> The item is indicated, but not monitored.	Reset	
KEY SW -SLOT	The Intelligent Key is not inserted into key slot	Off	PWC
	The Intelligent Key is inserted into key slot	On	
RKE OPE COUN1	During the operation of the Intelligent Key	Operation frequency of the Intelligent Key	L
RKE OPE COUN2	<b>NOTE:</b> The item is indicated, but not monitored.	—	
CONFIRM ID ALL	The key ID that the key slot receives is not recognized by any key ID registered to BCM.	Yet	M
	The key ID that the key slot receives is recognized by any key ID registered to BCM.	Done	
CONFIRM ID4	The key ID that the key slot receives is not recognized by the fourth key ID registered to BCM.	Yet	N
	The key ID that the key slot receives is recognized by the fourth key ID registered to BCM.	Done	O
CONFIRM ID3	The key ID that the key slot receives is not recognized by the third key ID registered to BCM.	Yet	
	The key ID that the key slot receives is recognized by the third key ID registered to BCM.	Done	P
CONFIRM ID2	The key ID that the key slot receives is not recognized by the second key ID registered to BCM.	Yet	
	The key ID that the key slot receives is recognized by the second key ID registered to BCM.	Done	

## BCM (BODY CONTROL MODULE)

### < ECU DIAGNOSIS INFORMATION >

Monitor Item	Condition	Value/Status
CONFIRM ID1	The key ID that the key slot receives is not recognized by the first key ID registered to BCM.	Yet
	The key ID that the key slot receives is recognized by the first key ID registered to BCM.	Done
TP 4	The ID of fourth Intelligent Key is not registered to BCM	Yet
	The ID of fourth Intelligent Key is registered to BCM	Done
TP 3	The ID of third Intelligent Key is not registered to BCM	Yet
	The ID of third Intelligent Key is registered to BCM	Done
TP 2	The ID of second Intelligent Key is not registered to BCM	Yet
	The ID of second Intelligent Key is registered to BCM	Done
TP 1	The ID of first Intelligent Key is not registered to BCM	Yet
	The ID of first Intelligent Key is registered to BCM	Done
AIR PRESS FL	Ignition switch ON (Only when the signal from the transmitter is received)	Air pressure of front LH tire
AIR PRESS FR	Ignition switch ON (Only when the signal from the transmitter is received)	Air pressure of front RH tire
AIR PRESS RR	Ignition switch ON (Only when the signal from the transmitter is received)	Air pressure of rear RH tire
AIR PRESS RL	Ignition switch ON (Only when the signal from the transmitter is received)	Air pressure of rear LH tire
ID REGST FL1	ID of front LH tire transmitter is registered	Done
	ID of front LH tire transmitter is not registered	Yet
ID REGST FR1	ID of front RH tire transmitter is registered	Done
	ID of front RH tire transmitter is not registered	Yet
ID REGST RR1	ID of rear RH tire transmitter is registered	Done
	ID of rear RH tire transmitter is not registered	Yet
ID REGST RL1	ID of rear LH tire transmitter is registered	Done
	ID of rear LH tire transmitter is not registered	Yet
WARNING LAMP	Tire pressure indicator OFF	Off
	Tire pressure indicator ON	On
BUZZER	Tire pressure warning alarm is not sounding	Off
	Tire pressure warning alarm is sounding	On

# BCM (BODY CONTROL MODULE)

< ECU DIAGNOSIS INFORMATION >

## TERMINAL LAYOUT

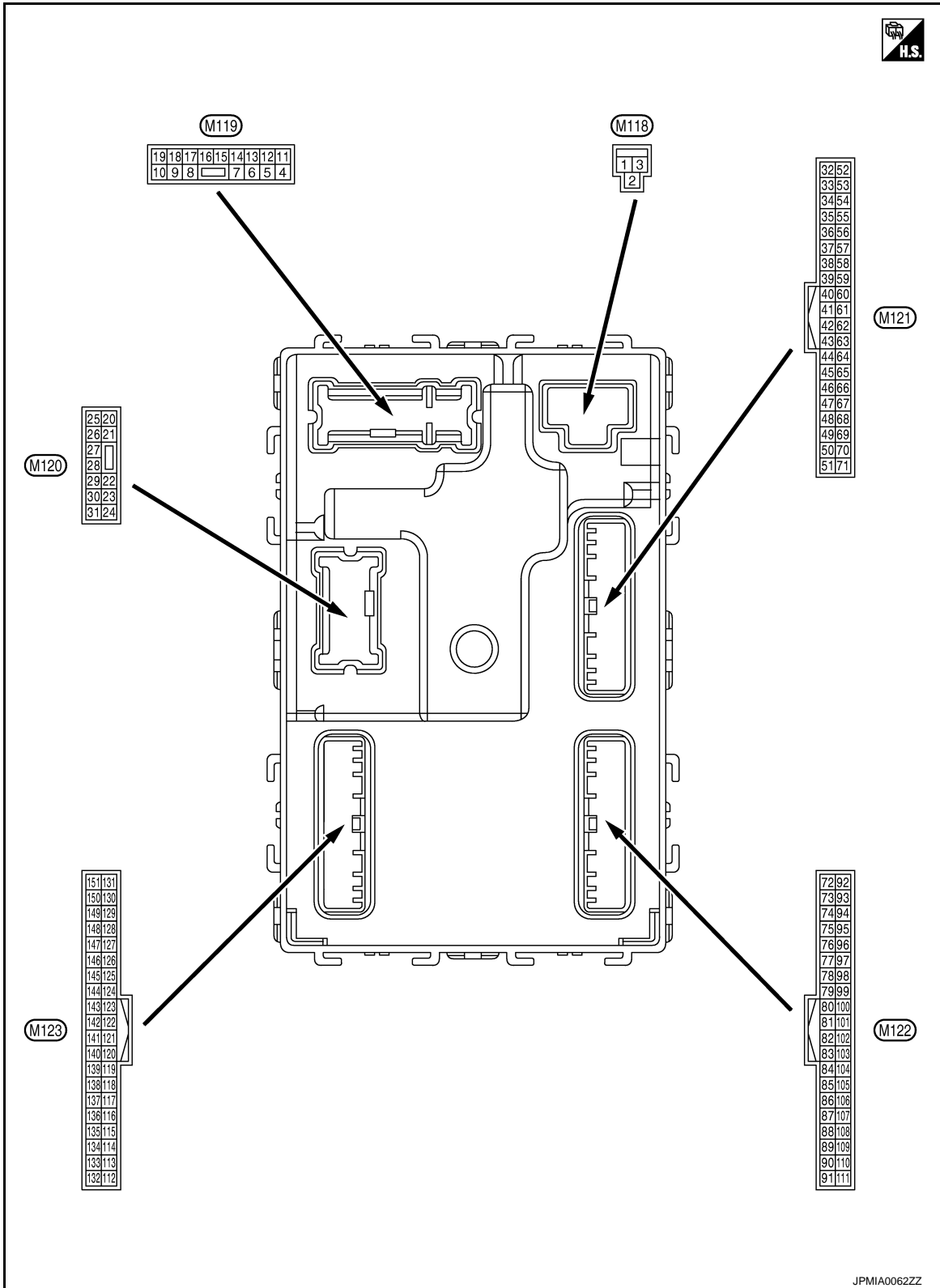

A  
B  
C  
D  
E  
F  
G  
H  
I  
J  
L  
M  
N  
O  
P

PWC

## PHYSICAL VALUES

# BCM (BODY CONTROL MODULE)

## < ECU DIAGNOSIS INFORMATION >

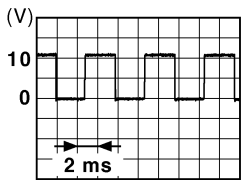
Terminal No. (Wire color)		Description		Condition		Value (Approx.)
		Signal name	Input/ Output			
+	-					
1 (W)	Ground	Battery power supply	Input	Ignition switch OFF		Battery voltage
2 (Y)	Ground	P/W power supply (BAT)	Output	Ignition switch OFF		12 V
3 (BG)	Ground	P/W power supply (RAP)	Output	Ignition switch ON		12 V
4 (LG)	Ground	Interior room lamp power supply	Output	Interior room lamp battery saver is activated. (Cuts the interior room lamp power supply)		0 V
				Interior room lamp battery saver is not activated. (Outputs the interior room lamp power supply)		12 V
5 (P)	Ground	Passenger door UN- LOCK	Output	Passenger door	UNLOCK (Actuator is activated)	12 V
					Other than UNLOCK (Actuator is not activated)	0 V
7 (SB)	Ground	Step lamp	Output	Step lamp	ON	0 V
					OFF	12 V
8 (V)	Ground	All doors, fuel lid LOCK	Output	All doors, fuel lid	LOCK (Actuator is activated)	12 V
					Other than LOCK (Actuator is not activated)	0 V
9 (G)	Ground	Driver door, fuel lid UNLOCK	Output	Driver door, fuel lid	UNLOCK (Actuator is activated)	12 V
					Other than UNLOCK (Actuator is not activated)	0 V
11 (R)	Ground	Battery power supply	Input	Ignition switch OFF		Battery voltage
13 (B)	Ground	Ground	—	Ignition switch ON		0 V
14 (W)	Ground	Push-button ignition switch illumination ground	Output	Tail lamp	OFF	0 V
					ON	<p style="text-align: center;"><b>NOTE:</b> When the illumination brightening/dimming level is in the neutral position.</p>  <p style="text-align: right; font-size: small;">JSNIA0010GB</p>
15 (BG)	Ground	ACC indicator lamp	Output	Ignition switch	OFF (LOCK indicator is not illuminated)	Battery voltage
					ACC	0 V

# BCM (BODY CONTROL MODULE)

## < ECU DIAGNOSIS INFORMATION >

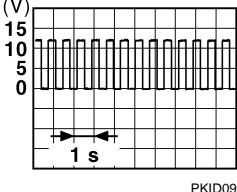
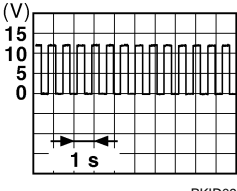
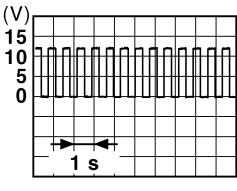
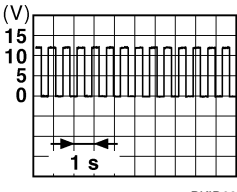
Terminal No. (Wire color)		Description		Condition	Value (Approx.)	
		Signal name	Input/ Output			
+	-					
17 (W)	Ground	Turn signal RH (Front)	Output	Ignition switch OFF	0 V	
				Ignition switch ON	Turn signal switch RH	 6.5 V
18 (BG)	Ground	Turn signal LH (Front)	Output	Ignition switch OFF	0 V	
				Ignition switch ON	Turn signal switch LH	 6.5 V
19 (V)	Ground	Interior room lamp control	Output	Interior room lamp	OFF	12 V
				ON	0 V	
20 (V)	Ground	Turn signal RH (Rear)	Output	Ignition switch OFF	0 V	
				Ignition switch ON	Turn signal switch RH	 6.5 V
23 (LG)	Ground	Trunk lid open	Output	Trunk lid	OPEN (Trunk lid opener actuator is activated)	12 V
				Other than OPEN (Trunk lid opener actuator is not activated)	0 V	
25 (Y)	Ground	Turn signal LH (Rear)	Output	Ignition switch OFF	0 V	
				Ignition switch ON	Turn signal switch LH	 6.5 V
30 (P)	Ground	Trunk room lamp	Output	Trunk room lamp	ON	0 V
				OFF	12 V	

A  
B  
C  
D  
E  
F  
G  
H  
I  
J  
L  
M  
N  
O  
P

PWC

# BCM (BODY CONTROL MODULE)

## < ECU DIAGNOSIS INFORMATION >

Terminal No. (Wire color)		Description		Condition	Value (Approx.)
+	-	Signal name	Input/ Output		
34 (SB)	Ground	Trunk room antenna (-)	Output	Ignition switch OFF	<p>JMKIA0062GB</p>
				When Intelligent Key is not in the passenger compart- ment	<p>JMKIA0063GB</p>
35 (V)	Ground	Trunk room antenna (+)	Output	Ignition switch OFF	<p>JMKIA0062GB</p>
				When Intelligent Key is not in the passenger compart- ment	<p>JMKIA0063GB</p>
38 (B)	Ground	Rear bumper anten- na (-)	Output	When the trunk lid opener re- quest switch is operated with ignition switch OFF	<p>JMKIA0062GB</p>
				When Intelligent Key is not in the antenna detection area	<p>JMKIA0063GB</p>

# BCM (BODY CONTROL MODULE)

## < ECU DIAGNOSIS INFORMATION >

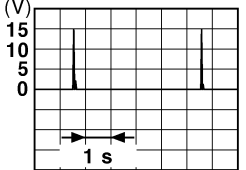
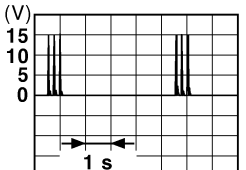
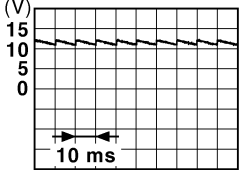
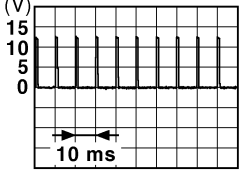
Terminal No. (Wire color)		Description		Condition	Value (Approx.)	
+	-	Signal name	Input/ Output			
39 (W)	Ground	Rear bumper antenna (+)	Output	When Intelligent Key is in the antenna detection area	 JMKIA0062GB	
				When the trunk lid opener request switch is operated with ignition switch OFF	 JMKIA0063GB	
47 (Y)	Ground	Ignition relay (IPDM E/R) control	Output	Ignition switch	OFF or ACC	12 V
				ON	0 V	
50 (BG)	Ground	Trunk room lamp switch	Input	Trunk room lamp switch	OFF (Trunk lid is closed)	 JPMIA0011GB
					ON (Trunk lid is opened)	0 V
52 (R)	Ground	Starter relay control	Output	Ignition switch ON (A/T models)	When selector lever is in P or N position	12 V
					When selector lever is not in P or N position	0 V
				Ignition switch ON (M/T models)	When the clutch pedal is depressed	Battery voltage
					When the clutch pedal is not depressed	0 V
60 (BR)	Ground	Push-button ignition switch (Push switch)	Input	Push-button ignition switch (Push switch)	Pressed	0 V
					Not pressed	Battery voltage
61 (SB)	Ground	Trunk lid opener request switch	Input	Trunk lid opener request switch	ON (Pressed)	0 V
					OFF (Not pressed)	 JPMIA0016GB
64 (G)	Ground	Intelligent Key warning buzzer (Engine room)	Output	Intelligent Key warning buzzer (Engine room)	Sounding	0 V
					Not sounding	12 V

A  
B  
C  
D  
E  
F  
G  
H  
I  
J  
L  
M  
N  
O  
P

PWC

# BCM (BODY CONTROL MODULE)

## < ECU DIAGNOSIS INFORMATION >

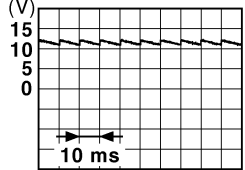
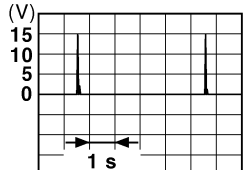
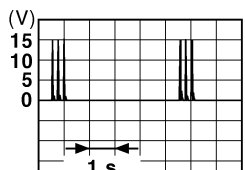
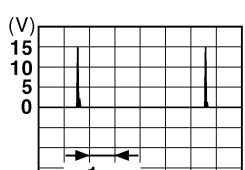
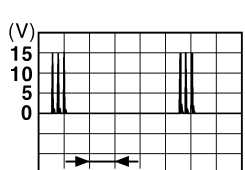
Terminal No. (Wire color)		Description		Condition	Value (Approx.)	
+	-	Signal name	Input/ Output			
67 (GR)	Ground	Trunk lid opener switch	Input	Trunk lid open- er switch	Pressed	0 V
					Not pressed	 <p style="text-align: right; font-size: small;">JPMIA0011GB</p>
72 (R)	Ground	Room antenna 2 (-) (Center console)	Output	Ignition switch OFF	When Intelligent Key is in the passenger compart- ment	 <p style="text-align: right; font-size: small;">JMKIA0062GB</p>
					When Intelligent Key is not in the passenger compart- ment	 <p style="text-align: right; font-size: small;">JMKIA0063GB</p>
73 (G)	Ground	Room antenna 2 (+) (Center console)	Output	Ignition switch OFF	When Intelligent Key is in the passenger compart- ment	 <p style="text-align: right; font-size: small;">JMKIA0062GB</p>
					When Intelligent Key is not in the passenger compart- ment	 <p style="text-align: right; font-size: small;">JMKIA0063GB</p>



# BCM (BODY CONTROL MODULE)

## < ECU DIAGNOSIS INFORMATION >

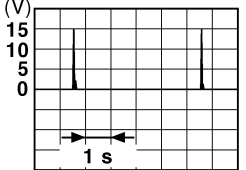
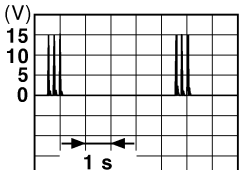
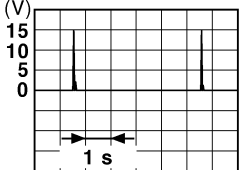
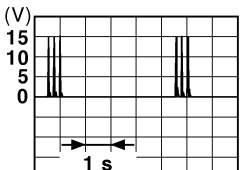
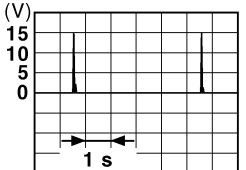
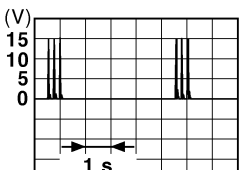
Terminal No. (Wire color)		Description		Condition	Value (Approx.)
+	-	Signal name	Input/ Output		
74 (SB)	Ground	Passenger door antenna (-)	Output	When Intelligent Key is in the antenna detection area	
				When the passenger door request switch is operated with ignition switch OFF	
75 (BR)	Ground	Passenger door antenna (+)	Output	When Intelligent Key is in the antenna detection area	
				When the passenger door request switch is operated with ignition switch OFF	
76 (V)	Ground	Driver door antenna (-)	Output	When Intelligent Key is in the antenna detection area	
				When the driver door request switch is operated with ignition switch OFF	

A  
B  
C  
D  
E  
F  
G  
H  
I  
J  
L  
M  
N  
O  
P

PWC

# BCM (BODY CONTROL MODULE)

## < ECU DIAGNOSIS INFORMATION >

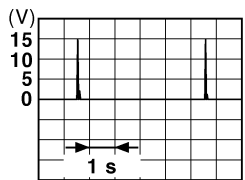
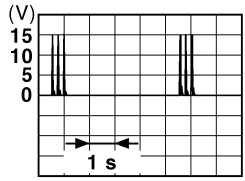
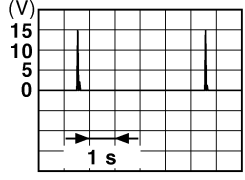
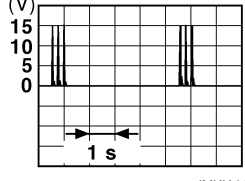
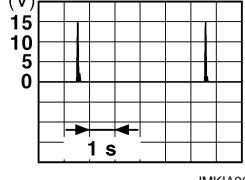
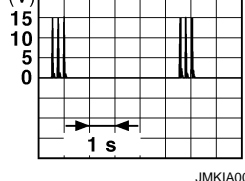
Terminal No. (Wire color)		Description		Condition	Value (Approx.)
+	-	Signal name	Input/ Output		
77 (LG)	Ground	Driver door antenna (+)	Output	When the driver door request switch is operated with ignition switch OFF	When Intelligent Key is in the antenna detection area  <small>JMKIA0062GB</small>
				When Intelligent Key is not in the antenna detection area	 <small>JMKIA0063GB</small>
78 (Y)	Ground	Room antenna 1 (-) (Instrument panel)	Output	Ignition switch OFF	When Intelligent Key is in the passenger compartment  <small>JMKIA0062GB</small>
				When Intelligent Key is not in the passenger compartment	 <small>JMKIA0063GB</small>
79 (BR)	Ground	Room antenna 1 (+) (Instrument panel)	Output	Ignition switch OFF	When Intelligent Key is in the passenger compartment  <small>JMKIA0062GB</small>
				When Intelligent Key is not in the passenger compartment	 <small>JMKIA0063GB</small>

# BCM (BODY CONTROL MODULE)

## < ECU DIAGNOSIS INFORMATION >

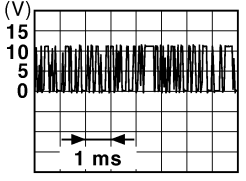
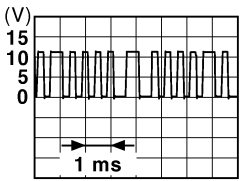
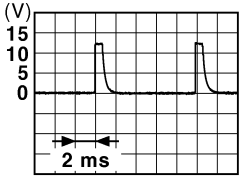
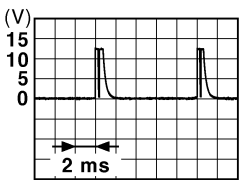
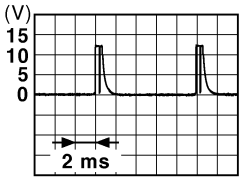
Terminal No. (Wire color)		Description		Condition		Value (Approx.)
+	-	Signal name	Input/ Output			
80 (GR)	Ground	NATS antenna amp.	Input/ Output	During waiting	Ignition switch is pressed while inserting the Intelligent Key into the key slot.	Just after pressing ignition switch. Pointer of tester should move.
81 (W)	Ground	NATS antenna amp.	Input/ Output	During waiting	Ignition switch is pressed while inserting the Intelligent Key into the key slot.	Just after pressing ignition switch. Pointer of tester should move.
82 (SB)	Ground	Ignition relay [Fuse block (J/B)] control	Output	Ignition switch	OFF or ACC	0 V
					ON	12 V
83 (Y)	Ground	Remote keyless entry receiver communication	Input/ Output	During waiting		 <p style="text-align: right; font-size: small;">JMKIA0064GB</p>
				When operating either button on the Intelligent Key		 <p style="text-align: right; font-size: small;">JMKIA0065GB</p>
87 (Y)	Ground	Combination switch INPUT 5	Input	Combination switch	All switches OFF (Wiper volume dial 4)	 <p style="text-align: right; font-size: small;">JPMIA0041GB</p> <p style="text-align: center;">1.4 V</p>
					Front fog lamp switch ON (Wiper volume dial 4)	 <p style="text-align: right; font-size: small;">JPMIA0037GB</p> <p style="text-align: center;">1.3 V</p>
					Any of the conditions below with all switches OFF <ul style="list-style-type: none"> <li>• Wiper volume dial 1</li> <li>• Wiper volume dial 2</li> <li>• Wiper volume dial 6</li> <li>• Wiper volume dial 7</li> </ul>	 <p style="text-align: right; font-size: small;">JPMIA0040GB</p> <p style="text-align: center;">1.3 V</p>

A  
B  
C  
D  
E  
F  
G  
H  
I  
J  
L  
M  
N  
O  
P

PWC

# BCM (BODY CONTROL MODULE)

## < ECU DIAGNOSIS INFORMATION >

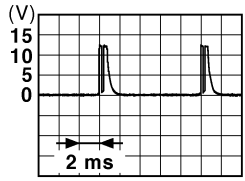
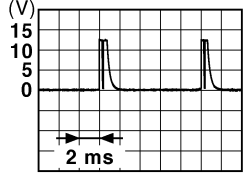
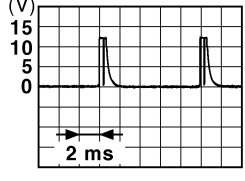
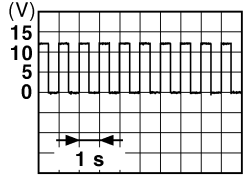
Terminal No. (Wire color)		Description		Condition	Value (Approx.)
		Signal name	Input/ Output		
+	-				
88 (BG)	Ground	Combination switch INPUT 3	Input	Combination switch	All switches OFF (Wiper volume dial 4) <div style="text-align: right;">  <p style="font-size: small; margin: 0;">JPMIA0041GB</p> <p style="margin: 0;">1.4 V</p> </div>
					Lighting switch HI (Wiper volume dial 4) <div style="text-align: right;">  <p style="font-size: small; margin: 0;">JPMIA0036GB</p> <p style="margin: 0;">1.3 V</p> </div>
					Lighting switch 2ND (Wiper volume dial 4) <div style="text-align: right;">  <p style="font-size: small; margin: 0;">JPMIA0037GB</p> <p style="margin: 0;">1.3 V</p> </div>
					Any of the conditions below with all switches OFF <ul style="list-style-type: none"> <li>• Wiper volume dial 1</li> <li>• Wiper volume dial 2</li> <li>• Wiper volume dial 3</li> </ul> <div style="text-align: right;">  <p style="font-size: small; margin: 0;">JPMIA0040GB</p> <p style="margin: 0;">1.3 V</p> </div>
90 (P)	Ground	CAN-L	Input/ Output	—	—
91 (L)	Ground	CAN-H	Input/ Output	—	—
92 (LG)	Ground	Key slot illumination	Output	Key slot illumi- nation	OFF <div style="text-align: right;"> <p style="margin: 0;">12 V</p> </div>
				Blinking	<div style="text-align: right;">  <p style="font-size: small; margin: 0;">JPMIA0015GB</p> <p style="margin: 0;">6.5 V</p> </div>
93 (GR)	Ground	ON indicator lamp	Output	Ignition switch	OFF (LOCK indicator is not illuminated) <div style="text-align: right;"> <p style="margin: 0;">Battery voltage</p> </div>
					ON <div style="text-align: right;"> <p style="margin: 0;">0 V</p> </div>

# BCM (BODY CONTROL MODULE)

## < ECU DIAGNOSIS INFORMATION >

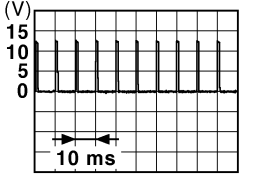
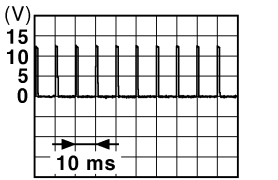



Terminal No. (Wire color)		Description		Condition		Value (Approx.)
		Signal name	Input/ Output			
+	-					
95 (BG)	Ground	ACC relay control	Output	Ignition switch	OFF	0 V
					ACC or ON	12 V
96 (GR)	Ground	A/T shift selector (Detention switch) power supply	Output	—		12 V
99 (R) <sup>*1</sup> (BR) <sup>*2</sup>	Ground	Selector lever P position switch (A/T models)	Input	Selector lever	P position	0 V
					Any position other than P	12 V
		ASCD clutch switch (M/T models)		ASCD clutch switch	OFF (Clutch pedal is depressed)	0 V
					ON (Clutch pedal is not depressed)	12 V
100 (Y)	Ground	Passenger door request switch	Input	Passenger door request switch	ON (Pressed)	0 V
					OFF (Not pressed)	 <p style="text-align: center;">1.0 V</p>
101 (P)	Ground	Driver door request switch	Input	Driver door request switch	ON (Pressed)	0 V
					OFF (Not pressed)	 <p style="text-align: center;">1.0 V</p>
102 (BG)	Ground	Blower fan motor relay control	Output	Ignition switch	OFF or ACC	0 V
					ON	12 V
103 (P)	Ground	Remote keyless entry receiver power supply	Output	Ignition switch OFF		12 V

A  
B  
C  
D  
E  
F  
G  
H  
I  
J  
L  
M  
N  
O  
P

PWC

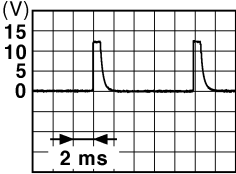

# BCM (BODY CONTROL MODULE)

## < ECU DIAGNOSIS INFORMATION >

Terminal No. (Wire color)		Description		Condition	Value (Approx.)	
+	-	Signal name	Input/ Output			
107 (LG)	Ground	Combination switch INPUT 1	Input	Combination switch (Wiper volume dial 4)	All switches OFF	 <p style="text-align: right;">1.4 V</p>
					Turn signal switch LH	 <p style="text-align: right;">1.3 V</p>
					Turn signal switch RH	 <p style="text-align: right;">1.3 V</p>
					Front wiper switch LO	 <p style="text-align: right;">1.3 V</p>
					Front washer switch ON	 <p style="text-align: right;">1.3 V</p>

# BCM (BODY CONTROL MODULE)

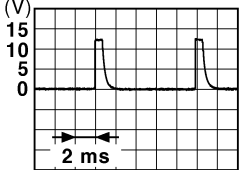
## < ECU DIAGNOSIS INFORMATION >

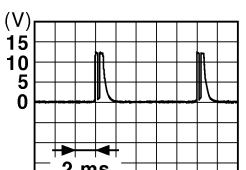
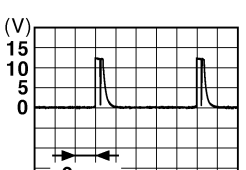
Terminal No. (Wire color)		Description		Condition	Value (Approx.)	
		Signal name	Input/ Output			
+	-					
108 (R)	Ground	Combination switch INPUT 4	Input	Combination switch	All switches OFF (Wiper volume dial 4)	 1.4 V
					Lighting switch AUTO (Wiper volume dial 4)	 1.3 V
					Lighting switch 1ST (Wiper volume dial 4)	 1.3 V
					Any of the conditions below with all switches OFF <ul style="list-style-type: none"> <li>• Wiper volume dial 1</li> <li>• Wiper volume dial 5</li> <li>• Wiper volume dial 6</li> </ul>	 1.3 V

A  
B  
C  
D  
E  
F  
G  
H  
I  
J  
L  
M  
N  
O  
P

PWC

# BCM (BODY CONTROL MODULE)

## < ECU DIAGNOSIS INFORMATION >

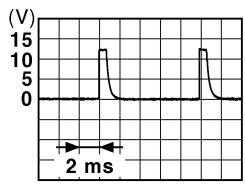
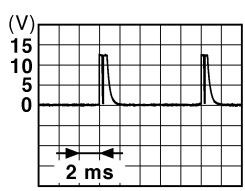
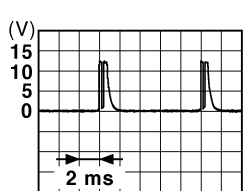
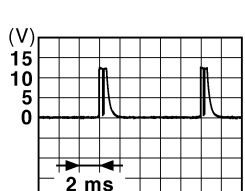
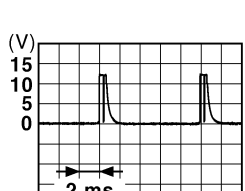
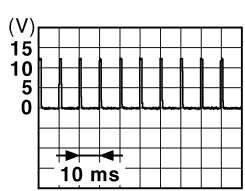
Terminal No. (Wire color)		Description		Condition	Value (Approx.)	
+	-	Signal name	Input/ Output			
109 (W)	Ground	Combination switch INPUT 2	Input	Combination switch (Wiper volume dial 4)	All switches OFF	 <p style="text-align: right;">1.4 V</p>
					Lighting switch PASS	 <p style="text-align: right;">1.3 V</p>
					Lighting switch 2ND	 <p style="text-align: right;">1.3 V</p>
					Front wiper switch INT/ AUTO	 <p style="text-align: right;">1.3 V</p>
					Front wiper switch HI	 <p style="text-align: right;">1.3 V</p>
					ON	0 V
110 (G)	Ground	Hazard switch	Input	Hazard switch	OFF	 <p style="text-align: right;">1.1 V</p>



# BCM (BODY CONTROL MODULE)

## < ECU DIAGNOSIS INFORMATION >

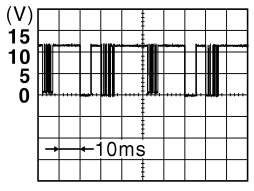
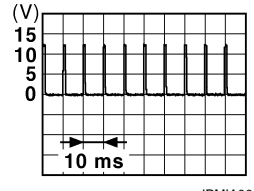
Terminal No. (Wire color)		Description		Condition	Value (Approx.)
		Signal name	Input/ Output		
+	-				
112 (R)	Ground	Rain sensor serial link	Input/ Output	Ignition switch ON	 <p style="text-align: center;">8.7 V</p>
113 (BG)	Ground	Optical sensor	Input	Ignition switch ON	When bright outside of the vehicle Close to 5 V
				Ignition switch OFF	When dark outside of the vehicle Close to 0 V
114 (R)	Ground	Clutch interlock switch	Input	Clutch interlock switch OFF	OFF (Clutch pedal is not depressed) 0 V
				Clutch interlock switch ON	ON (Clutch pedal is depressed) Battery voltage
116 (SB)	Ground	Stop lamp switch 1	Input	—	Battery voltage
118 (BR)	Ground	Stop lamp switch 2 (Without ICC)	Input	Stop lamp switch OFF	OFF (Brake pedal is not depressed) 0 V
				Stop lamp switch ON	ON (Brake pedal is depressed) Battery voltage
		Stop lamp switch 2 (With ICC)		Stop lamp switch OFF	Stop lamp switch OFF (Brake pedal is not depressed) and ICC brake hold relay OFF 0 V
				Stop lamp switch ON	Stop lamp switch ON (Brake pedal is depressed) or ICC brake hold relay ON Battery voltage
119 (SB)	Ground	Driver side door lock assembly (Unlock sensor)	Input	Driver door LOCK status (Unlock sensor switch OFF)	 <p style="text-align: center;">1.1 V</p>
				Driver door UNLOCK status (Unlock switch sensor ON)	0 V
121 (SB)	Ground	Key slot switch	Input	When the Intelligent Key is inserted into key slot	12 V
				When the Intelligent Key is not inserted into key slot	0 V
123 (V)	Ground	IGN feedback	Input	Ignition switch OFF or ACC	0 V
				Ignition switch ON	Battery voltage

A  
B  
C  
D  
E  
F  
G  
H  
I  
J  
L  
M  
N  
O  
P

PWC

# BCM (BODY CONTROL MODULE)

## < ECU DIAGNOSIS INFORMATION >

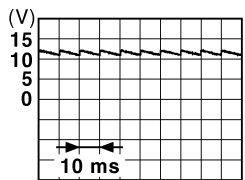
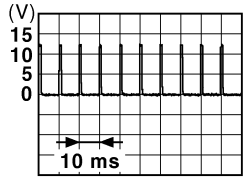
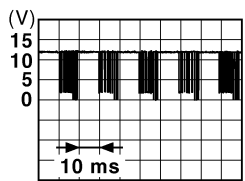
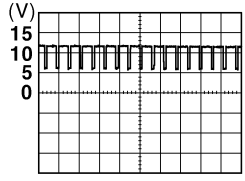
Terminal No. (Wire color)		Description		Condition	Value (Approx.)	
		Signal name	Input/ Output			
+	-					
124 (R)	Ground	Passenger door switch	Input	Passenger door switch	OFF (Door close)	 <small>JPMIA0011GB</small> 11.8 V
					ON (Door open)	0 V
129 (BG)	Ground	Trunk lid opener cancel switch	Input	Trunk lid open- er cancel switch	CANCEL	 <small>JPMIA0012GB</small> 1.1 V
					ON	0 V
132 (V)	Ground	Power window switch communication	Input/ Output	Ignition switch ON	Ignition switch ON	 <small>JPMIA0013GB</small> 10.2 V
					Ignition switch OFF or ACC	12 V
133 (L)	Ground	Push-button ignition switch illumination	Output	Push-button ig- nition switch il- lumination	ON (Tail lamps OFF)	9.5 V
					ON (Tail lamps ON)	<p style="text-align: center;"><b>NOTE:</b> The pulse width of this wave is varied by the illumination bright- ening/dimming level.</p>  <small>JPMIA0159GB</small>
					OFF	0 V
134 (LG)	Ground	LOCK indicator lamp	Output	LOCK indicator lamp	OFF	Battery voltage
					ON	0 V
137 (BG)	Ground	Receiver and sensor ground	Input	Ignition switch ON	Ignition switch ON	0 V
138 (V)	Ground	Receiver and sensor power supply	Output	Ignition switch	OFF	0 V
					ACC or ON	5.0 V

# BCM (BODY CONTROL MODULE)

## < ECU DIAGNOSIS INFORMATION >

Terminal No. (Wire color)		Description		Condition	Value (Approx.)
+	-	Signal name	Input/ Output		
139 (L)	Ground	Tire pressure receiver communication	Input/ Output	Ignition switch ON	<p style="text-align: right;">OCC3881D</p>
				When receiving the signal from the transmitter	<p style="text-align: right;">OCC3880D</p>
140*1 (B)	Ground	Selector lever P/N position	Input	Selector lever	P or N position: 12 V Except P and N positions: 0 V
				ON	0 V
141 (W)	Ground	Security indicator lamp	Output	Security indicator lamp	Blinking: OFF: 12 V
				Turn signal switch RH	10.7 V
142 (BR)	Ground	Combination switch OUTPUT 5	Output	Combination switch (Wiper volume dial 4)	All switches OFF: 0 V Lighting switch 1ST Lighting switch HI Lighting switch 2ND Turn signal switch RH: 10.7 V
				Combination switch	All switches OFF (Wiper volume dial 4): 0 V Front wiper switch HI (Wiper volume dial 4) Any of the conditions below with all switches OFF: <ul style="list-style-type: none"> <li>• Wiper volume dial 1</li> <li>• Wiper volume dial 2</li> <li>• Wiper volume dial 3</li> <li>• Wiper volume dial 6</li> <li>• Wiper volume dial 7</li> </ul>
				Combination switch	<p style="text-align: right;">JPMIA0032GB</p>
				Combination switch	10.7 V

A  
B  
C  
D  
E  
F  
G  
H  
I  
J  
L  
M  
N  
O  
P

PWC

# BCM (BODY CONTROL MODULE)

## < ECU DIAGNOSIS INFORMATION >

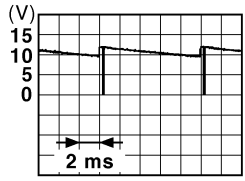
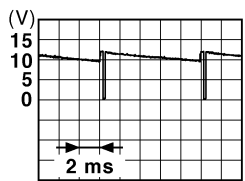
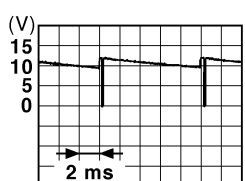
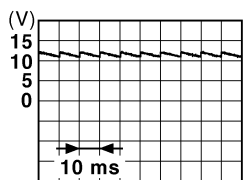
Terminal No. (Wire color)		Description		Condition	Value (Approx.)	
+	-	Signal name	Input/ Output			
144 (G)	Ground	Combination switch OUTPUT 2	Output	Combination switch	All switches OFF (Wiper volume dial 4)	0 V
					Front washer switch ON (Wiper volume dial 4)	 <p style="text-align: right; font-size: small;">JPMIA0033GB</p>
Any of the conditions below with all switches OFF					10.7 V	
<ul style="list-style-type: none"> <li>• Wiper volume dial 1</li> <li>• Wiper volume dial 5</li> <li>• Wiper volume dial 6</li> </ul>						
145 (L)	Ground	Combination switch OUTPUT 3	Output	Combination switch (Wiper volume dial 4)	All switches OFF	0 V
					Front wiper switch INT/ AUTO	 <p style="text-align: right; font-size: small;">JPMIA0034GB</p>
					Front wiper switch LO	
Lighting switch AUTO					10.7 V	
146 (SB)	Ground	Combination switch OUTPUT 4	Output	Combination switch (Wiper volume dial 4)	All switches OFF	0 V
					Front fog lamp switch ON	 <p style="text-align: right; font-size: small;">JPMIA0035GB</p>
					Lighting switch 2ND	
					Lighting switch PASS	
Turn signal switch LH					10.7 V	
150 (GR)	Ground	Driver door switch	Input	Driver door switch	OFF (Door close)	 <p style="text-align: right; font-size: small;">JPMIA0011GB</p>
					ON (Door open)	0 V
151 (G)	Ground	Rear window defogger relay control	Output	Rear window defogger	Active	0 V
				Not activated	Battery voltage	

- \*1: A/T models
- \*2: M/T models

# BCM (BODY CONTROL MODULE)

< ECU DIAGNOSIS INFORMATION >

## Wiring Diagram - BCM -

INFOID:000000008778747

For connector terminal arrangements, harness layouts, and alphabets in a  (option abbreviation; if not described in wiring diagram), refer to [GI-12, "Connector Information"](#).

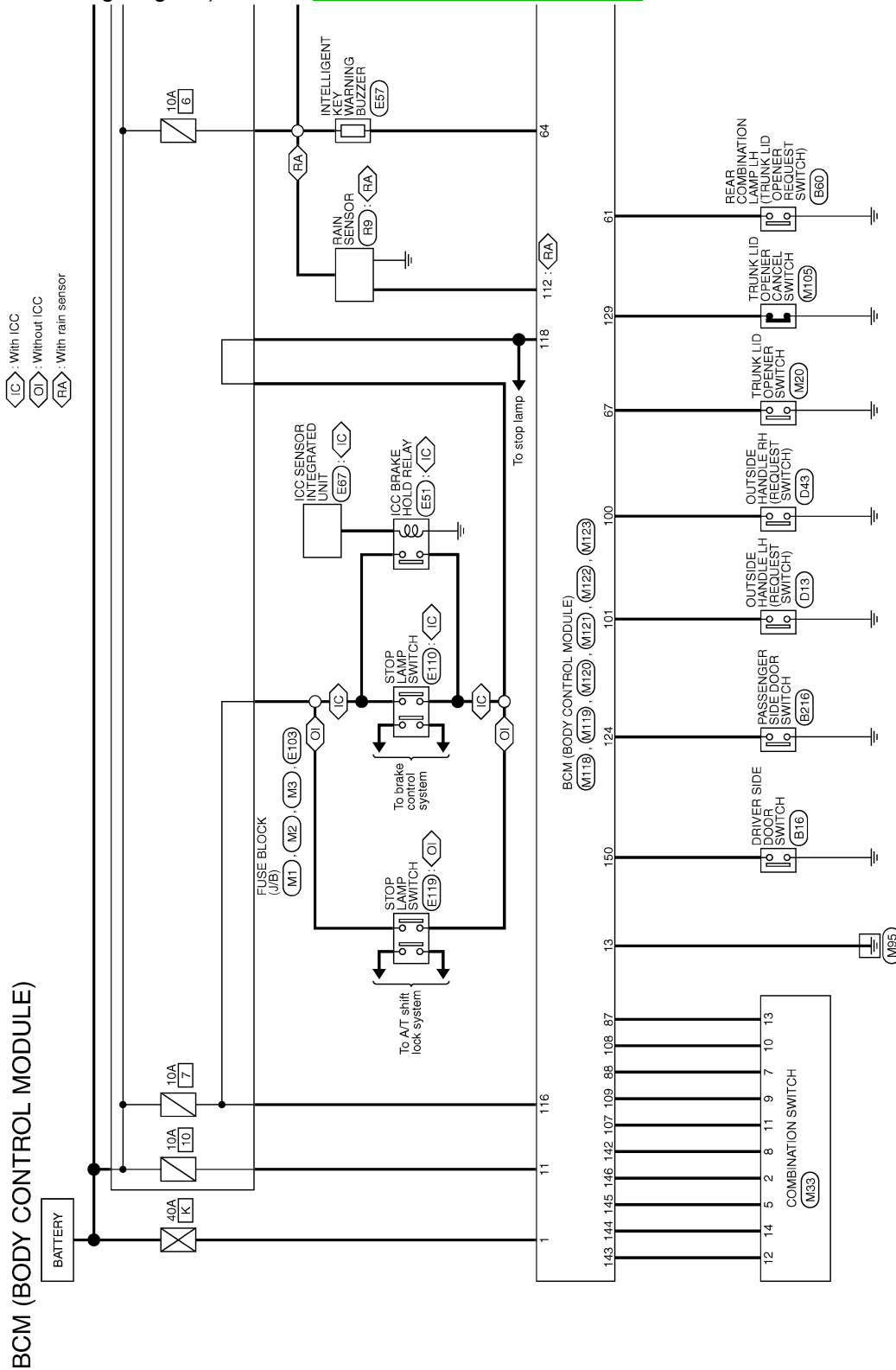

2011/07/13

JRMWC4423GB

PWC

# BCM (BODY CONTROL MODULE)

< ECU DIAGNOSIS INFORMATION >

M : With M/T

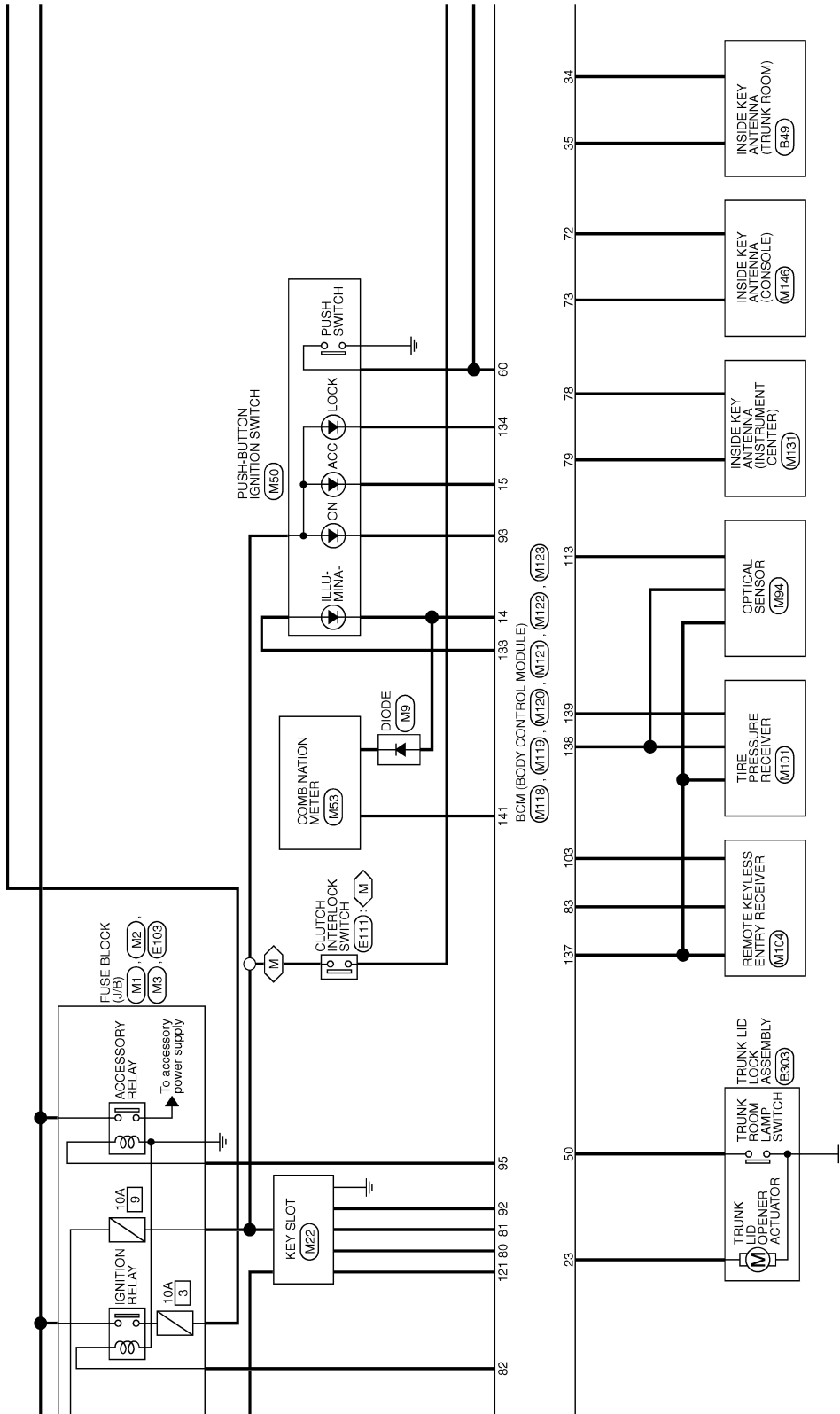

JRMWC4424GB

# BCM (BODY CONTROL MODULE)

< ECU DIAGNOSIS INFORMATION >

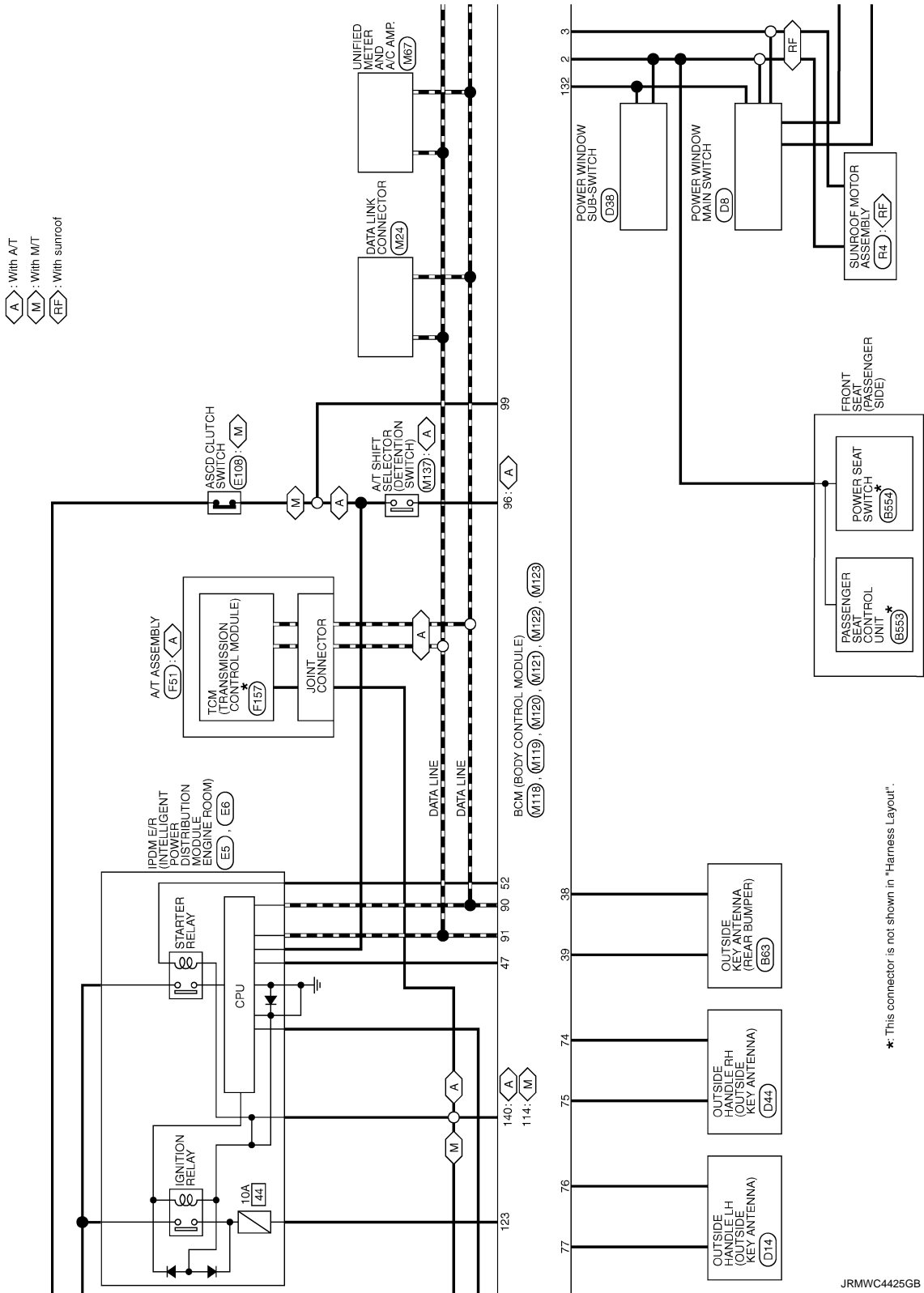

A  
B  
C  
D  
E  
F  
G  
H  
I  
J  
L  
M  
N  
O  
P



# BCM (BODY CONTROL MODULE)

< ECU DIAGNOSIS INFORMATION >

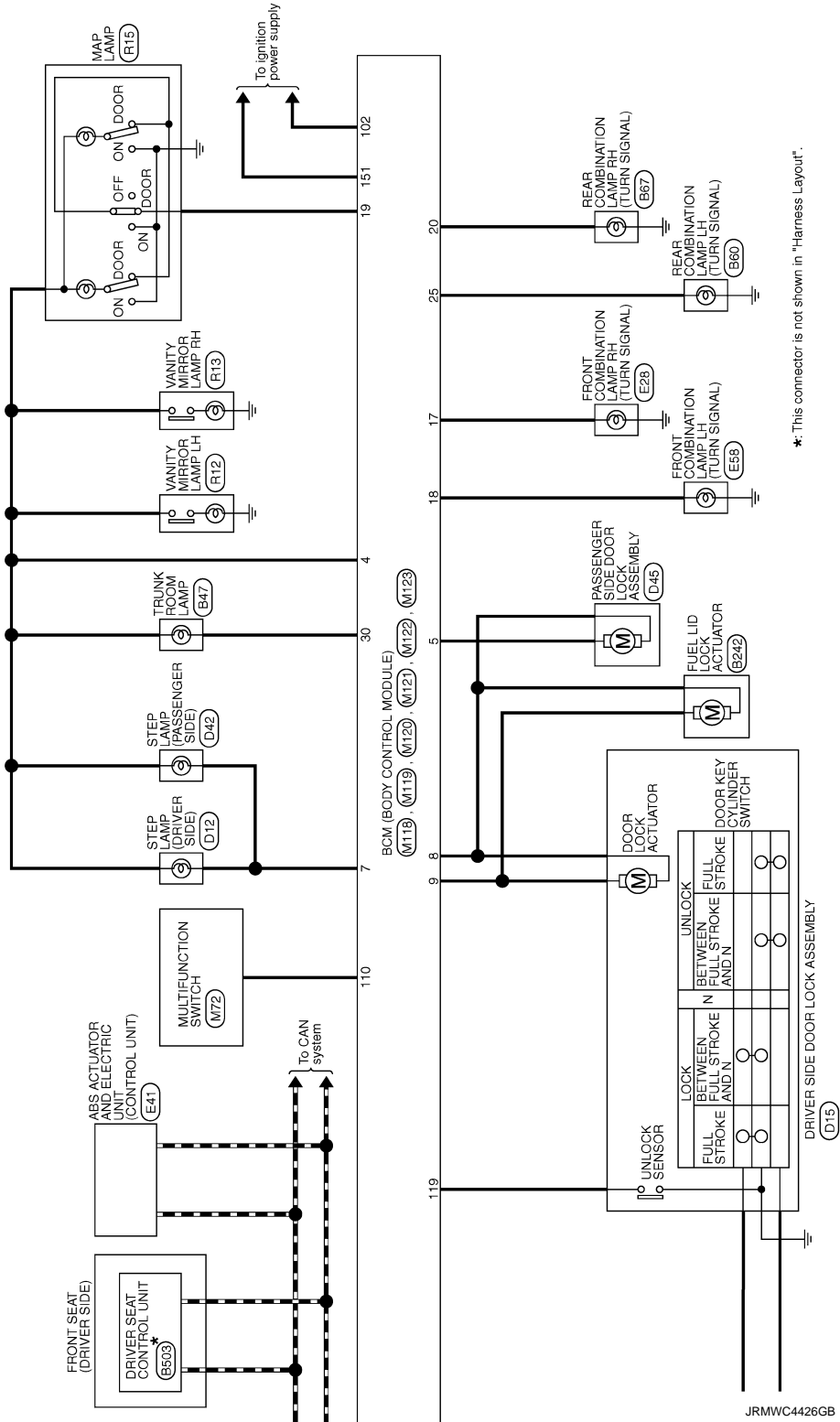

## Fail-safe

INFOID:000000008778748

## FAIL-SAFE CONTROL BY DTC

BCM performs fail-safe control when any DTC are detected.



## BCM (BODY CONTROL MODULE)

### < ECU DIAGNOSIS INFORMATION >

Display contents of CONSULT	Fail-safe	Cancellation
B2190: NATS ANTENNA AMP	Inhibit engine cranking	Erase DTC
B2191: DIFFERENCE OF KEY	Inhibit engine cranking	Erase DTC
B2192: ID DISCORD BCM-ECM	Inhibit engine cranking	Erase DTC
B2193: CHAIN OF BCM-ECM	Inhibit engine cranking	Erase DTC
B2195: ANTI-SCANNING	Inhibit engine cranking	Ignition switch ON → OFF
B2560: STARTER CONT RELAY	Inhibit engine cranking	500 ms after the following CAN signal communication status becomes consistent <ul style="list-style-type: none"> <li>• Starter control relay signal</li> <li>• Starter relay status signal</li> </ul>
B2608: STARTER RELAY	Inhibit engine cranking	500 ms after the following signal communication status becomes consistent <ul style="list-style-type: none"> <li>• Starter motor relay control signal</li> <li>• Starter relay status signal (CAN)</li> </ul>
B260A: IGNITION RELAY	Inhibit engine cranking	500 ms after the following conditions are fulfilled <ul style="list-style-type: none"> <li>• IGN relay (IPDM E/R) control signal: OFF (12 V)</li> <li>• Ignition ON signal (CAN to IPDM E/R): OFF (Request signal)</li> <li>• Ignition ON signal (CAN from IPDM E/R): OFF (Condition signal)</li> </ul>
B260F: ENG STATE SIG LOST	Maintains the power supply position attained at the time of DTC detection	When any of the following conditions are fulfilled <ul style="list-style-type: none"> <li>• Power position changes to ACC</li> <li>• Receives engine status signal (CAN)</li> </ul>
B2617: BCM	Inhibit engine cranking	1 second after the starter motor relay control inside BCM becomes normal
B2618: BCM	Inhibit engine cranking	1 second after the ignition relay (IPDM E/R) control inside BCM becomes normal
B261E: VEHICLE TYPE	Inhibit engine cranking	BCM initialization
B26E8: CLUTCH SW	Inhibit engine cranking	When any of the following BCM recognition conditions are fulfilled <ul style="list-style-type: none"> <li>• Status 1 <ul style="list-style-type: none"> <li>- Clutch switch signal (CAN from ECM): ON</li> <li>- Clutch interlock switch signal: OFF (0 V)</li> </ul> </li> <li>• Status 2 <ul style="list-style-type: none"> <li>- Clutch switch signal (CAN from ECM): OFF</li> <li>- Clutch interlock switch signal: ON (Battery voltage)</li> </ul> </li> </ul>

### DTC Inspection Priority Chart

INFOID:000000008778749

If some DTCs are displayed at the same time, perform inspections one by one based on the following priority chart.

Priority	DTC
1	B2562: LOW VOLTAGE
2	<ul style="list-style-type: none"> <li>• U1000: CAN COMM</li> <li>• U1010: CONTROL UNIT(CAN)</li> </ul>
3	<ul style="list-style-type: none"> <li>• B2190: NATS ANTENNA AMP</li> <li>• B2191: DIFFERENCE OF KEY</li> <li>• B2192: ID DISCORD BCM-ECM</li> <li>• B2193: CHAIN OF BCM-ECM</li> <li>• B2195: ANTI-SCANNING</li> </ul>

# BCM (BODY CONTROL MODULE)

## < ECU DIAGNOSIS INFORMATION >

Priority	DTC
4	<ul style="list-style-type: none"> <li>• B2553: IGNITION RELAY</li> <li>• B2555: STOP LAMP</li> <li>• B2556: PUSH-BTN IGN SW</li> <li>• B2557: VEHICLE SPEED</li> <li>• B2560: STARTER CONT RELAY</li> <li>• B2601: SHIFT POSITION</li> <li>• B2602: SHIFT POSITION</li> <li>• B2603: SHIFT POSI STATUS</li> <li>• B2604: PNP/CLUTCH SW</li> <li>• B2605: PNP/CLUTCH SW</li> <li>• B2608: STARTER RELAY</li> <li>• B260A: IGNITION RELAY</li> <li>• B260F: ENG STATE SIG LOST</li> <li>• B2614: BCM</li> <li>• B2615: BCM</li> <li>• B2616: BCM</li> <li>• B2617: BCM</li> <li>• B2618: BCM</li> <li>• B261A: PUSH-BTN IGN SW</li> <li>• B261E: VEHICLE TYPE</li> <li>• B26E8: CLUTCH SW</li> <li>• B26EA: KEY REGISTRATION</li> <li>• C1729: VHCL SPEED SIG ERR</li> <li>• U0415: VEHICLE SPEED</li> </ul>
5	<ul style="list-style-type: none"> <li>• C1704: LOW PRESSURE FL</li> <li>• C1705: LOW PRESSURE FR</li> <li>• C1706: LOW PRESSURE RR</li> <li>• C1707: LOW PRESSURE RL</li> <li>• C1708: [NO DATA] FL</li> <li>• C1709: [NO DATA] FR</li> <li>• C1710: [NO DATA] RR</li> <li>• C1711: [NO DATA] RL</li> <li>• C1716: [PRESSDATA ERR] FL</li> <li>• C1717: [PRESSDATA ERR] FR</li> <li>• C1718: [PRESSDATA ERR] RR</li> <li>• C1719: [PRESSDATA ERR] RL</li> <li>• C1734: CONTROL UNIT</li> </ul>
6	<ul style="list-style-type: none"> <li>• B2621: INSIDE ANTENNA</li> <li>• B2622: INSIDE ANTENNA</li> <li>• B2623: INSIDE ANTENNA</li> </ul>

### DTC Index

INFOID:000000008778750

#### NOTE:

The details of time display are as follows.

- CRNT: A malfunction is detected now.
- PAST: A malfunction was detected in the past.

IGN counter is displayed on Freeze Frame Data. For details of Freeze Frame Data, refer to [BCS-16, "COMMON ITEM : CONSULT Function \(BCM - COMMON ITEM\)"](#).

CONSULT display	Fail-safe	Freeze Frame Data •Vehicle Speed •Odo/Trip Meter •Vehicle condition	Intelligent Key warning lamp ON	Tire pressure monitor warning lamp ON	Refer- ence page
No DTC is detected. further testing may be required.	—	—	—	—	—
U1000: CAN COMM	—	—	—	—	<a href="#">BCS-36</a>
U1010: CONTROL UNIT(CAN)	—	—	—	—	<a href="#">BCS-37</a>
U0415: VEHICLE SPEED	—	—	—	—	<a href="#">BCS-38</a>
B2190: NATS ANTENNA AMP	×	—	—	—	<a href="#">SEC-51</a>

## BCM (BODY CONTROL MODULE)

### < ECU DIAGNOSIS INFORMATION >

CONSULT display	Fail-safe	Freeze Frame Data •Vehicle Speed •Odo/Trip Meter •Vehicle condition	Intelligent Key warning lamp ON	Tire pressure monitor warning lamp ON	Refer- ence page
B2191: DIFFERENCE OF KEY	×	—	—	—	<a href="#">SEC-54</a>
B2192: ID DISCORD BCM-ECM	×	—	—	—	<a href="#">SEC-55</a>
B2193: CHAIN OF BCM-ECM	×	—	—	—	<a href="#">SEC-57</a>
B2195: ANTI-SCANNING	×	—	—	—	<a href="#">SEC-58</a>
B2553: IGNITION RELAY	—	×	—	—	<a href="#">PCS-48</a>
B2555: STOP LAMP	—	×	—	—	<a href="#">SEC-59</a>
B2556: PUSH-BTN IGN SW	—	×	×	—	<a href="#">SEC-61</a>
B2557: VEHICLE SPEED	×	×	×	—	<a href="#">SEC-63</a>
B2560: STARTER CONT RELAY	×	×	×	—	<a href="#">SEC-64</a>
B2562: LOW VOLTAGE	—	×	—	—	<a href="#">BCS-39</a>
B2601: SHIFT POSITION	×	×	×	—	<a href="#">SEC-65</a>
B2602: SHIFT POSITION	×	×	×	—	<a href="#">SEC-68</a>
B2603: SHIFT POSI STATUS	×	×	×	—	<a href="#">SEC-70</a>
B2604: PNP/CLUTCH SW	×	×	×	—	<a href="#">SEC-73</a>
B2605: PNP/CLUTCH SW	×	×	×	—	<a href="#">SEC-75</a>
B2608: STARTER RELAY	×	×	×	—	<a href="#">SEC-77</a>
B260A: IGNITION RELAY	×	×	×	—	<a href="#">PCS-50</a>
B260F: ENG STATE SIG LOST	×	×	×	—	<a href="#">SEC-79</a>
B2614: BCM	—	×	×	—	<a href="#">PCS-52</a>
B2615: BCM	—	×	×	—	<a href="#">PCS-54</a>
B2616: BCM	—	×	×	—	<a href="#">PCS-56</a>
B2617: BCM	×	×	×	—	<a href="#">SEC-83</a>
B2618: BCM	×	×	×	—	<a href="#">PCS-58</a>
B261A: PUSH-BTN IGN SW	—	×	×	—	<a href="#">PCS-59</a>
B261E: VEHICLE TYPE	×	×	× (Turn ON for 15 seconds)	—	<a href="#">SEC-85</a>
B2621: INSIDE ANTENNA	—	×	—	—	<a href="#">DLK-55</a>
B2622: INSIDE ANTENNA	—	×	—	—	<a href="#">DLK-57</a>
B2623: INSIDE ANTENNA	—	×	—	—	<a href="#">DLK-59</a>
B26E8: CLUTCH SW	×	×	×	—	<a href="#">SEC-80</a>
B26EA: KEY REGISTRATION	—	×	× (Turn ON for 15 seconds)	—	<a href="#">SEC-82</a>
C1704: LOW PRESSURE FL	—	—	—	×	<a href="#">WT-19</a>
C1705: LOW PRESSURE FR	—	—	—	×	
C1706: LOW PRESSURE RR	—	—	—	×	
C1707: LOW PRESSURE RL	—	—	—	×	
C1708: [NO DATA] FL	—	—	—	×	<a href="#">WT-21</a>
C1709: [NO DATA] FR	—	—	—	×	
C1710: [NO DATA] RR	—	—	—	×	
C1711: [NO DATA] RL	—	—	—	×	

A  
B  
C  
D  
E  
F  
G  
H  
I  
J  
PWC  
L  
M  
N  
O  
P

## BCM (BODY CONTROL MODULE)

### < ECU DIAGNOSIS INFORMATION >

CONSULT display	Fail-safe	Freeze Frame Data •Vehicle Speed •Odo/Trip Meter •Vehicle condition	Intelligent Key warning lamp ON	Tire pressure monitor warning lamp ON	Refer- ence page
C1716: [PRESSDATA ERR] FL	—	—	—	×	<a href="#">WT-24</a>
C1717: [PRESSDATA ERR] FR	—	—	—	×	
C1718: [PRESSDATA ERR] RR	—	—	—	×	
C1719: [PRESSDATA ERR] RL	—	—	—	×	
C1729: VHCL SPEED SIG ERR	—	—	—	×	<a href="#">WT-25</a>
C1734: CONTROL UNIT	—	—	—	×	<a href="#">WT-26</a>

# POWER WINDOW MAIN SWITCH

< ECU DIAGNOSIS INFORMATION >

## POWER WINDOW MAIN SWITCH

Reference Value

INFOID:000000008164992

TERMINAL LAYOUT

PHYSICAL VALUES

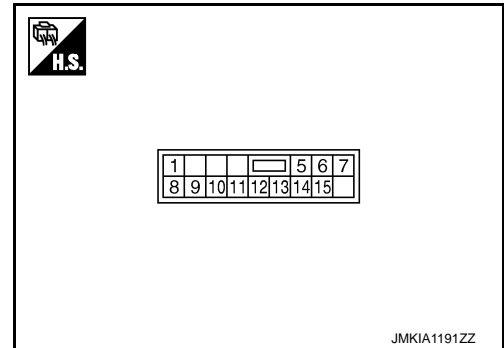

### POWER WINDOW MAIN SWITCH

Terminal No. (Wire color)		Description		Condition	Voltage [V] (Approx.)
+	-	Signal name	Input/ Output		
1 (Y)	Ground	Battery power supply	Input	—	Battery voltage
5 (BG)	Ground	Encoder power supply	Output	When ignition switch ON or automatic window ad- justing operates	Battery voltage
8 (L)	Ground	Driver side power window mo- tor UP signal	Output	When power window main switch (Driver side) is op- erated UP	Battery voltage
9 (LG)	Ground	Encoder pulse signal 2	Input	When power window mo- tor operates	 JMKIA0070GB
10 (SB)	Ground	Ignition switch power signal	Input	IGN SW ON	Battery voltage
				IGN SW OFF	0
11 (BR)	Ground	Driver side power window mo- tor DOWN signal	Output	When power window main switch (Driver side) is op- erated DOWN	Battery voltage
12 (V)	Ground	Power window serial link	Input/ Output	Ignition switch ON	 JPMIA0013GB

A  
B  
C  
D  
E  
F  
G  
H  
I  
J  
L  
M  
N  
O  
P

PWC

# POWER WINDOW MAIN SWITCH

## < ECU DIAGNOSIS INFORMATION >

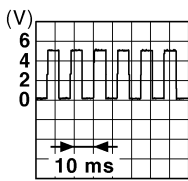
Terminal No. (Wire color)		Description		Condition	Voltage [V] (Approx.)
+	-	Signal name	Input/ Output		
13 (R)	Ground	Encoder pulse signal 1	Input	When power window motor operates	 <p style="text-align: right; font-size: small;">JMkia0070GB</p>
14 (G)	Ground	Encoder ground	—	—	0
15 (B)	Ground	Ground	—	—	0

# POWER WINDOW MAIN SWITCH

< ECU DIAGNOSIS INFORMATION >

## Wiring Diagram - POWER WINDOW CONTROL SYSTEM -

INFOID:000000008164993

For connector terminal arrangements, harness layouts, and alphabets in a  (option abbreviation; if not described in wiring diagram), refer to [GI-12, "Connector Information"](#).

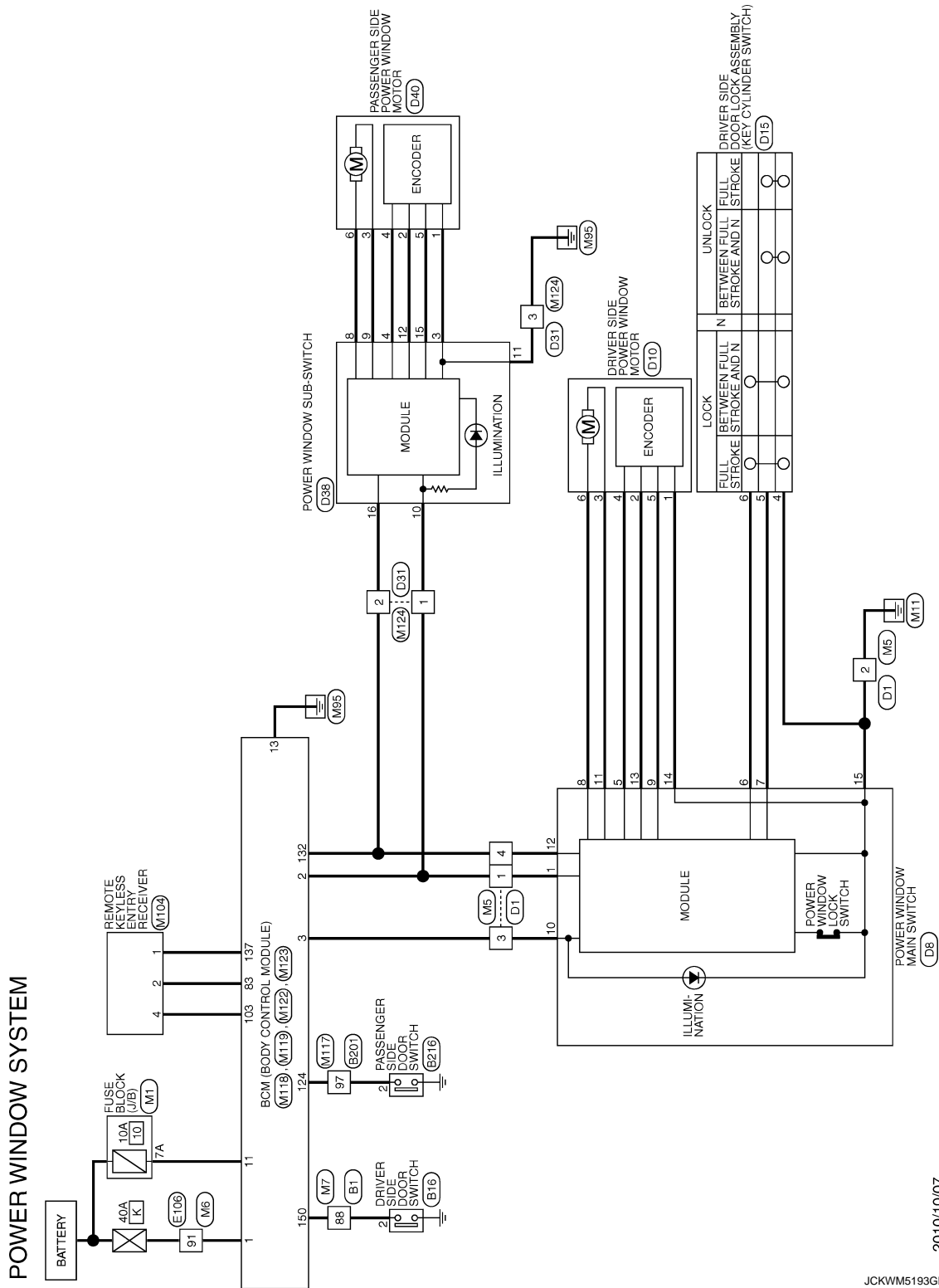

Fail-Safe

FAIL-SAFE CONTROL

A  
B  
C  
D  
E  
F  
G  
H  
I  
J  
L  
M  
N  
O  
P

PWC

JCKWM5193GB

2010/10/07

INFOID:000000008164994

# POWER WINDOW MAIN SWITCH

## < ECU DIAGNOSIS INFORMATION >

Switches to fail-safe control when malfunction is detected in encoder signal that detects up/down speed and direction of door glass. Switches to fail-safe control when a signal that is out of the specified value is detected between the fully closed position and the actual position of the glass.

Malfunction	Malfunction condition
Pulse sensor malfunction	When one pulse signal that is the specified value or more is detected continuously for the specified time or more, while door glass is being operated UP or DOWN.
Both pulse sensor malfunction	When both pulse signal are not detected continuously for the specified time or more, while door glass is being operated UP or DOWN.
Pulse direction malfunction	When a pulse indicating that the window is moving in the opposite direction against the power window motor is detected for the specified value or more, while door glass is being operated UP or DOWN.
Glass recognition position malfunction 1	When the actual door glass position that is out of the specified value is detected compared to the door glass fully closed position memorized in module, while door is being operated UP or DOWN.
Glass recognition position malfunction 2	When pulse count that is out of door glass full stroke value or more is detected, while door glass is being operated UP or DOWN.
Fully closed position update malfunction	When door glass is continuously operated UP and DOWN for the specified value or more without fully closing door glass (approximately 10 times or more).

In fail-safe control, the system changes to a non-initialized condition and the following function do not operate.

- AUTO UP operation
- Anti-pinch function
- Automatic window adjusting function
- Door key cylinder switch power window function

When fail-safe control is activated, perform initializing operation to recover. If a malfunction is detected in power window switch or more, fail-safe control is activated again.



# POWER WINDOW SUB-SWITCH

< ECU DIAGNOSIS INFORMATION >

## POWER WINDOW SUB-SWITCH

Reference Value

INFOID:000000008164995

TERMINAL LAYOUT

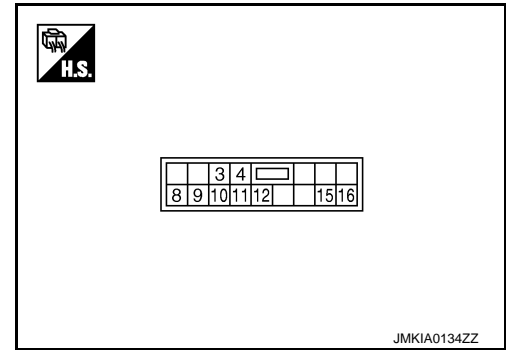

PHYSICAL VALUES

Terminal No. (Wire color)		Description		Condition	Voltage [V] (Approx.)
+	-	Signal name	Input/ Output		
3 (G)	Ground	Encoder ground	—	—	0
4 (BG)	Ground	Encoder power supply	Output	When ignition switch ON or automatic window operates adjusting	Battery voltage
8 (L)	Ground	Power window motor UP signal	Output	When power window motor is operated UP	Battery voltage
9 (BR)	Ground	Power window motor DOWN signal	Output	When power window motor is operated DOWN	Battery voltage
10 (W)	Ground	Battery power supply	Input	—	Battery voltage
11 (B)	Ground	Ground	—	—	0
12 (R)	Ground	Encoder pulse signal 1	Input	When power window motor operates	

PWC

# POWER WINDOW SUB-SWITCH

## < ECU DIAGNOSIS INFORMATION >

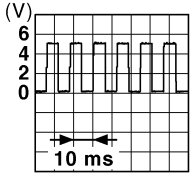
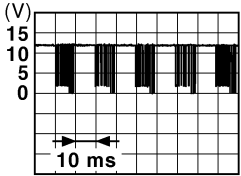
Terminal No. (Wire color)		Description		Condition	Voltage [V] (Approx.)
+	-	Signal name	Input/ Output		
15 (LG)	Ground	Encoder pulse signal 2	Input	When power window motor operates	 <p style="text-align: right; font-size: small;">JMK1A0070GB</p>
16 (Y)	Ground	Power window serial link	Input/ Output	Ignition switch ON	 <p style="text-align: right; font-size: small;">JPMIA0013GB</p>

# POWER WINDOW SUB-SWITCH

< ECU DIAGNOSIS INFORMATION >

## Wiring Diagram - POWER WINDOW CONTROL SYSTEM -

INFOID:000000008164996

For connector terminal arrangements, harness layouts, and alphabets in a  (option abbreviation; if not described in wiring diagram), refer to [GI-12, "Connector Information"](#).

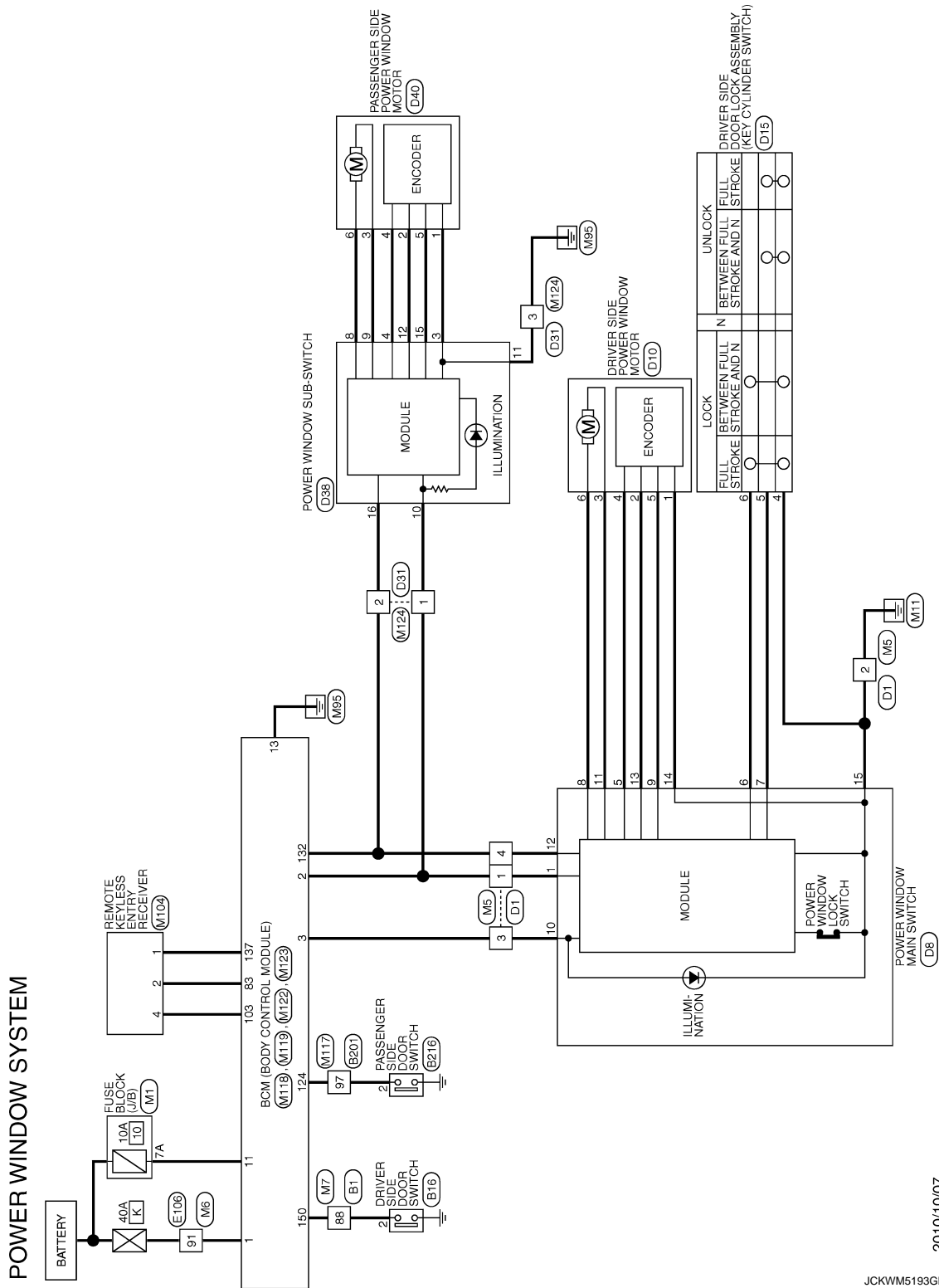

Fail-Safe

FAIL-SAFE CONTROL

A  
B  
C  
D  
E  
F  
G  
H  
I  
J  
L  
M  
N  
O  
P

PWC

JCKWM5193GB

2010/10/07

INFOID:000000008164997

# POWER WINDOW SUB-SWITCH

## < ECU DIAGNOSIS INFORMATION >

Switches to fail-safe control when malfunction is detected in encoder signal that detects up/down speed and direction of door glass. Switches to fail-safe control when a signal that is out of the specified value is detected between the fully closed position and the actual position of the glass.

Malfunction	Malfunction condition
Pulse sensor malfunction	When one pulse signal that is the specified value or more is detected continuously for the specified time or more, while door glass is being operated UP or DOWN.
Both pulse sensor malfunction	When both pulse signal are not detected continuously for the specified time or more, while door glass is being operated UP or DOWN.
Pulse direction malfunction	When a pulse indicating that the window is moving in the opposite direction against the power window motor is detected for the specified value or more, while door glass is being operated UP or DOWN.
Glass recognition position malfunction 1	When the actual door glass position that is out of the specified value is detected compared to the door glass fully closed position memorized in module, while door is being operated UP or DOWN.
Glass recognition position malfunction 2	When pulse count that is out of door glass full stroke value or more is detected, while door glass is being operated UP or DOWN.
Fully closed position update malfunction	When door glass is continuously operated UP and DOWN for the specified value or more without fully closing door glass (approximately 10 times or more).

In fail-safe control, the system changes to a non-initialized condition and the following function do not operate.

- AUTO UP operation
- Anti-pinch function
- Automatic window adjusting function
- Door key cylinder switch power window function

When fail-safe control is activated, perform initializing operation to recover. If a malfunction is detected in power window switch or more, fail-safe control is activated again.

# POWER WINDOWS DO NOT OPERATE WITH ANY POWER WINDOW SWITCHES

< SYMPTOM DIAGNOSIS >

## SYMPTOM DIAGNOSIS

POWER WINDOWS DO NOT OPERATE WITH ANY POWER WINDOW SWITCHES

### Description

INFOID:000000008164998

All power windows do not operate via power window main switch and power window sub-switch.

### Diagnosis Procedure

INFOID:000000008164999

#### 1. CHECK BCM POWER SUPPLY AND GROUND CIRCUIT

Check BCM power supply and ground circuit.  
Refer to [PWC-14, "BCM : Diagnosis Procedure"](#).

Is the inspection result normal?

YES >> GO TO 2.

NO >> Repair or replace the malfunctioning parts.

#### 2. CONFIRM THE OPERATION

Confirm the operation again.

Is the result normal?

YES >> Check intermittent incident. Refer to [GI-43, "Intermittent Incident"](#)

NO >> GO TO 1.

A  
B  
C  
D  
E  
F  
G  
H  
I  
J  
L  
M  
N  
O  
P

PWC

# DRIVER SIDE POWER WINDOW ALONE DOES NOT OPERATE

< SYMPTOM DIAGNOSIS >

---

## DRIVER SIDE POWER WINDOW ALONE DOES NOT OPERATE

### Description

INFOID:000000008165000

Driver side power window does not operate using power window main switch.

### Diagnosis Procedure

INFOID:000000008165001

#### 1. CHECK POWER WINDOW MAIN SWITCH POWER SUPPLY AND GROUND CIRCUIT

---

Check power window main switch power supply and ground circuit.

Refer to [PWC-14, "POWER WINDOW MAIN SWITCH : Diagnosis Procedure"](#).

Is the inspection result normal?

YES >> GO TO 2.

NO >> Repair or replace the malfunctioning parts.

#### 2. CHECK DRIVER SIDE POWER WINDOW MOTOR

---

Check driver side power window motor.

Refer to [PWC-17, "DRIVER SIDE : Component Function Check"](#).

Is the measurement value within the specification?

YES >> GO TO 3.

NO >> Repair or replace the malfunctioning parts.

#### 3. CONFIRM THE OPERATION

---

Confirm the operation again.

Is the result normal?

YES >> Check intermittent incident. Refer to [GI-43, "Intermittent Incident"](#).

NO >> GO TO 1.

# PASSENGER SIDE POWER WINDOW ALONE DOES NOT OPERATE

< SYMPTOM DIAGNOSIS >

## PASSENGER SIDE POWER WINDOW ALONE DOES NOT OPERATE WHEN POWER WINDOW MAIN SWITCH IS OPERATED

WHEN POWER WINDOW MAIN SWITCH IS OPERATED : Description INFOID:000000008165002

Passenger side power window operates using power window sub-switch but does not operate using power window main switch.

WHEN POWER WINDOW MAIN SWITCH IS OPERATED : Diagnosis Procedure INFOID:000000008165003

### 1.CHECK POWER WINDOW SUB-SWITCH POWER SUPPLY AND GROUND CIRCUIT

Check power window sub-switch power supply and ground circuit.  
Refer to [PWC-15. "POWER WINDOW SUB-SWITCH : Diagnosis Procedure"](#).

Is the inspection result normal?

- YES >> GO TO 2.
- NO >> Repair or replace the malfunctioning parts.

### 2.CHECK POWER WINDOW SUB-SWITCH SERIAL LINK CIRCUIT

Check power window sub-switch serial link circuit.  
Refer to [PWC-27. "POWER WINDOW SUB-SWITCH : Component Function Check"](#).

Is the inspection result normal?

- YES >> GO TO 3.
- NO >> Repair or replace the malfunctioning parts.

### 3.CONFIRM THE OPERATION

Confirm the operation again.

Is the result normal?

- YES >> Check intermittent incident. Refer to [GI-43. "Intermittent Incident"](#).
- NO >> GO TO 1.

## WHEN POWER WINDOW SUB-SWITCH IS OPERATED

WHEN POWER WINDOW SUB-SWITCH IS OPERATED : Description INFOID:000000008165004

Passenger side power window operates using power window main switch but not using power window sub-switch.

WHEN POWER WINDOW SUB-SWITCH IS OPERATED : Diagnosis Procedure INFOID:000000008165005

### 1.CHECK POWER WINDOW SUB-SWITCH POWER SUPPLY AND GROUND CIRCUIT

Check power window sub-switch power supply and ground circuit.  
Refer to [PWC-15. "POWER WINDOW SUB-SWITCH : Diagnosis Procedure"](#).

Is the inspection result normal?

- YES >> GO TO 2.
- NO >> Repair or replace the malfunctioning parts.

### 2.CONFIRM THE OPERATION

Confirm the operation again.

Is the result normal?

- YES >> Check intermittent incident. Refer to [GI-43. "Intermittent Incident"](#).
- NO >> GO TO 1.

## WITH BOTH POWER WINDOW MAIN SWITCH AND POWER WINDOW SUB-SWITCH

WITH BOTH POWER WINDOW MAIN SWITCH AND POWER WINDOW SUB-

A  
B  
C  
D  
E  
F  
G  
H  
I  
J  
L  
M  
N  
O  
P

PWC

# PASSENGER SIDE POWER WINDOW ALONE DOES NOT OPERATE

< SYMPTOM DIAGNOSIS >

SWITCH : Description

INFOID:000000008165006

Passenger side power window operates using power window main switch and power window sub-switch.

WITH BOTH POWER WINDOW MAIN SWITCH AND POWER WINDOW SUB-SWITCH : Diagnosis Procedure

INFOID:000000008165007

## 1.CHECK PASSENGER SIDE POWER WINDOW MOTOR

Check passenger side power window motor.

Refer to [PWC-18. "PASSENGER SIDE : Component Function Check"](#).

Is the measurement value within the specification?

YES >> GO TO 2.

NO >> Repair or replace the malfunctioning parts.

## 2.CONFIRM THE OPERATION

Confirm the operation again.

Is the result normal?

YES >> Check intermittent incident. Refer to [GI-43. "Intermittent Incident"](#).

NO >> GO TO 1.



# ANTI-PINCH FUNCTION DOES NOT OPERATE

< SYMPTOM DIAGNOSIS >

## ANTI-PINCH FUNCTION DOES NOT OPERATE DRIVER SIDE

### DRIVER SIDE : Description

INFOID:000000008165008

Anti-pinch function does not operate when power window up operated.

### DRIVER SIDE : Diagnosis Procedure

INFOID:000000008165009

#### 1.CHECK AUTO UP OPERATION

Check AUTO UP operation.

Is the inspection result normal?

YES >> GO TO 2.

NO >> Refer to [PWC-74, "DRIVER SIDE : Diagnosis Procedure"](#).

#### 2.CONFIRM THE OPERATION

Confirm the operation again.

Is the result normal?

YES >> Check intermittent incident. Refer to [GI-43, "Intermittent Incident"](#).

NO >> GO TO 1.

## PASSENGER SIDE

### PASSENGER SIDE : Description

INFOID:000000008165010

Anti-pinch function does not operate when power window up operated.

### PASSENGER SIDE : Diagnosis Procedure

INFOID:000000008165011

#### 1.CHECK AUTO UP OPERATION

Check AUTO UP operation.

Is the inspection result normal?

YES >> GO TO 2.

NO >> Refer to [PWC-74, "PASSENGER SIDE : Diagnosis Procedure"](#).

#### 2.CONFIRM THE OPERATION

Confirm the operation again.

Is the result normal?

YES >> Check intermittent incident. Refer to [GI-43, "Intermittent Incident"](#).

NO >> GO TO 1.

A  
B  
C  
D  
E  
F  
G  
H  
I  
J  
L  
M  
N  
O  
P

PWC

# AUTO OPERATION DOES NOT OPERATE BUT MANUAL OPERATES NORMALLY

< SYMPTOM DIAGNOSIS >

## AUTO OPERATION DOES NOT OPERATE BUT MANUAL OPERATES NORMALLY DRIVER SIDE

### DRIVER SIDE : Diagnosis Procedure

INFOID:000000008165012

#### 1.PERFORM INITIALIZATION PROCEDURE

Initialization procedure is performed and operation is confirmed.

Refer to [PWC-5, "ADDITIONAL SERVICE WHEN REMOVING BATTERY NEGATIVE TERMINAL : Special Repair Requirement"](#).

Is the inspection result normal?

- YES >> INSPECTION END
- NO >> GO TO 2.

#### 2.CHECK ENCODER (DRIVER SIDE) CIRCUIT

Check encoder (driver side) circuit.

Refer to [PWC-21, "DRIVER SIDE : Component Function Check"](#).

Is the inspection result normal?

- YES >> GO TO 3.
- NO >> Repair or replace the malfunctioning parts.

#### 3.CONFIRM THE OPERATION

Confirm the operation again.

Is the result normal?

- YES >> Check intermittent incident. Refer to [GI-43, "Intermittent Incident"](#).
- NO >> GO TO 1.

## PASSENGER SIDE

### PASSENGER SIDE : Diagnosis Procedure

INFOID:000000008165013

#### 1.PERFORM INITIALIZATION PROCEDURE

Initialization procedure is performed and operation is confirmed.

Refer to [PWC-5, "ADDITIONAL SERVICE WHEN REMOVING BATTERY NEGATIVE TERMINAL : Special Repair Requirement"](#).

Is the inspection result normal?

- YES >> INSPECTION END
- NO >> GO TO 2.

#### 2.CHECK ENCODER (PASSENGER SIDE) CIRCUIT

Check encoder (passenger side) circuit.

Refer to [PWC-23, "PASSENGER SIDE : Component Function Check"](#).

Is the inspection result normal?

- YES >> GO TO 3.
- NO >> Repair or replace the malfunctioning parts.

#### 3.CONFIRM THE OPERATION

Confirm the operation again.

Is the result normal?

- YES >> Check intermittent incident. Refer to [GI-43, "Intermittent Incident"](#).
- NO >> GO TO 1.

# POWER WINDOW RETAINED POWER FUNCTION DOES NOT OPERATE NORMALLY

< SYMPTOM DIAGNOSIS >

## POWER WINDOW RETAINED POWER FUNCTION DOES NOT OPERATE NORMALLY

### Description

INFOID:000000008165014

Retained power function does not operate after ignition switch turns OFF.

### Diagnosis Procedure

INFOID:000000008165015

#### 1.CHECK DOOR SWITCH

Check door switch.

Refer to [DLK-62. "Component Function Check"](#).

Is the inspection result normal?

YES >> GO TO 2.

NO >> Repair or replace the malfunctioning parts.

#### 2.CONFIRM THE OPERATION

Confirm the operation again.

Is the result normal?

YES >> Check intermittent incident. Refer to [GI-43. "Intermittent Incident"](#).

NO >> GO TO 1.

A  
B  
C  
D  
E  
F  
G  
H  
I  
J  
L  
M  
N  
O  
P

PWC

# DOOR KEY CYLINDER SWITCH DOES NOT OPERATE POWER WINDOWS

< SYMPTOM DIAGNOSIS >

---

## DOOR KEY CYLINDER SWITCH DOES NOT OPERATE POWER WINDOWS

### Description

INFOID:000000008165016

Power window does not operate when locking or unlocking a door using door key cylinder.

### Diagnosis Procedure

INFOID:000000008165017

#### 1.PERFORM INITIALIZATION PROCEDURE

---

Initialization procedure is executed and operation is confirmed.

Refer to [PWC-5. "ADDITIONAL SERVICE WHEN REMOVING BATTERY NEGATIVE TERMINAL : Special Repair Requirement"](#).

Is the inspection result normal?

YES >> INSPECTION END  
NO >> GO TO 2.

#### 2.CHECK DRIVER SIDE DOOR LOCK ASSEMBLY (DOOR KEY CYLINDER SWITCH)

---

Check driver side door lock assembly (door key cylinder switch).

Refer to [DLK-73. "Component Function Check"](#).

Is the inspection result normal?

YES >> GO TO 3.  
NO >> Repair or replace the malfunctioning parts.

#### 3.CONFIRM THE OPERATION

---

Confirm the operation again.

Is the result normal?

YES >> Check intermittent incident. Refer to [GI-43. "Intermittent Incident"](#).  
NO >> GO TO 1.

# KEYLESS POWER WINDOW DOWN DOES NOT OPERATE

< SYMPTOM DIAGNOSIS >

## KEYLESS POWER WINDOW DOWN DOES NOT OPERATE

### Description

INFOID:000000008165018

Power window down does not operate when pressing unlock button on Intelligent Key.

### Diagnosis Procedure

INFOID:000000008165019

#### 1.CHECK REMOTE KEYLESS ENTRY FUNCTION

Check remote keyless entry function.

Does door lock/unlock with Intelligent Key button?

YES >> GO TO 2.

NO >> Refer to [DLK-149, "Description"](#).

#### 2.CHECK POWER WINDOW OPERATION

Check power window operation.

Does power window operate up/down using power window main switch?

YES >> GO TO 3.

NO >> Refer to [DLK-149, "Diagnosis Procedure"](#).

#### 3.CHECK "PW DOWN SET" SETTING IN "WORK SUPPORT"

Check "PW DOWN SET" setting in "WORK SUPPORT".

Refer to [DLK-49, "INTELLIGENT KEY : CONSULT Function \(BCM - INTELLIGENT KEY\)"](#).

Is the inspection result normal?

YES >> GO TO 4.

NO >> Set "PW DOWN SET" setting in "WORK SUPPORT".

#### 4.CONFIRM THE OPERATION

Confirm the operation again.

Is the result normal?

YES >> Check intermittent incident. Refer to [GI-43, "Intermittent Incident"](#).

NO >> GO TO 1.

A  
B  
C  
D  
E  
F  
G  
H  
I  
J  
L  
M  
N  
O  
P

PWC

## POWER WINDOW LOCK SWITCH DOES NOT FUNCTION

< SYMPTOM DIAGNOSIS >

---

### POWER WINDOW LOCK SWITCH DOES NOT FUNCTION

#### Diagnosis Procedure

INFOID:000000008165020

#### 1. REPLACE POWER WINDOW MAIN SWITCH

---

Replace power window main switch.

>> Refer to [PWC-84. "Removal and Installation"](#).

# POWER WINDOW SWITCH ILLUMINATION DOES NOT ILLUMINATE

< SYMPTOM DIAGNOSIS >

## POWER WINDOW SWITCH ILLUMINATION DOES NOT ILLUMINATE DRIVER SIDE

DRIVER SIDE : Diagnosis Procedure

INFOID:000000008165021

### 1. REPLACE POWER WINDOW MAIN SWITCH

Replace power window main switch.

>> Refer to [PWC-84, "Removal and Installation"](#).

## PASSENGER SIDE

PASSENGER SIDE : Diagnosis Procedure

INFOID:000000008165022

### 1. REPLACE POWER WINDOW SUB-SWITCH

Replace power window sub-switch.

>> Refer to [PWC-84, "Removal and Installation"](#).

A  
B  
C  
D  
E  
F  
G  
H  
I  
J  
L  
M  
N  
O  
P

PWC

# AUTOMATIC WINDOW ADJUSTING FUNCTION DOES NOT OPERATE

< SYMPTOM DIAGNOSIS >

## AUTOMATIC WINDOW ADJUSTING FUNCTION DOES NOT OPERATE DRIVER SIDE

DRIVER SIDE : Diagnosis Procedure

INFOID:000000008165023

### 1. CHECK AUTO UP OPERATION

Check AUTO UP operation.

Is the inspection result normal?

YES >> GO TO 2.

NO >> Refer to [PWC-74. "DRIVER SIDE : Diagnosis Procedure"](#).

### 2. CHECK DOOR SWITCH

Check door switch.

Refer to [DLK-62. "Component Function Check"](#).

Is the inspection result normal?

YES >> GO TO 3.

NO >> Repair or replace the malfunctioning parts.

### 3. CHECK POWER WINDOW SERIAL LINK (POWER WINDOW MAIN SWITCH)

Check power window serial link (power window main switch)

Refer to [PWC-26. "POWER WINDOW MAIN SWITCH : Component Function Check"](#)

Is the result normal?

YES >> GO TO 4.

NO >> Repair or replace the malfunctioning parts

### 4. CONFIRM THE OPERATION

Confirm the operation again.

Is the result normal?

YES >> Check intermittent incident. Refer to [GI-43. "Intermittent Incident"](#).

NO >> GO TO 1.

## PASSENGER SIDE

PASSENGER SIDE : Diagnosis Procedure

INFOID:000000008165024

### 1. PERFORM INITIALIZATION PROCEDURE

Initialization procedure is performed and operation is confirmed.

Refer to [PWC-5. "ADDITIONAL SERVICE WHEN REMOVING BATTERY NEGATIVE TERMINAL : Special Repair Requirement"](#).

Is the inspection result normal?

YES >> INSPECTION END

NO >> GO TO 2.

### 2. CHECK DOOR SWITCH

Check door switch.

Refer to [DLK-62. "Component Function Check"](#).

Is the inspection result normal?

YES >> GO TO 3.

NO >> Repair or replace the malfunctioning parts.

### 3. CHECK POWER WINDOW SERIAL LINK (POWER WINDOW SUB-SWITCH)

Check power window serial link (power window sub-switch)

Refer to [PWC-27. "POWER WINDOW SUB-SWITCH : Component Function Check"](#)

Is the result normal?

YES >> GO TO 4.

NO >> Repair or replace the malfunctioning parts



# AUTOMATIC WINDOW ADJUSTING FUNCTION DOES NOT OPERATE

< SYMPTOM DIAGNOSIS >

---

## 4.CONFIRM THE OPERATION

---

Confirm the operation again.

Is the result normal?

- YES >> Check intermittent incident. Refer to [GI-43. "Intermittent Incident"](#).
- NO >> GO TO 1.

A  
B  
C  
D  
E  
F  
G  
H  
I  
J  
L  
M  
N  
O  
P

PWC

# PRECAUTIONS

< PRECAUTION >

## PRECAUTION

### PRECAUTIONS

#### Precaution for Supplemental Restraint System (SRS) "AIR BAG" and "SEAT BELT PRE-TENSIONER"

INFOID:000000008165025

The Supplemental Restraint System such as "AIR BAG" and "SEAT BELT PRE-TENSIONER", used along with a front seat belt, helps to reduce the risk or severity of injury to the driver and front passenger for certain types of collision. This system includes seat belt switch inputs and dual stage front air bag modules. The SRS system uses the seat belt switches to determine the front air bag deployment, and may only deploy one front air bag, depending on the severity of a collision and whether the front occupants are belted or unbelted. Information necessary to service the system safely is included in the "SRS AIR BAG" and "SEAT BELT" of this Service Manual.

#### **WARNING:**

**Always observe the following items for preventing accidental activation.**

- **To avoid rendering the SRS inoperative, which could increase the risk of personal injury or death in the event of a collision that would result in air bag inflation, all maintenance must be performed by an authorized NISSAN/INFINITI dealer.**
- **Improper maintenance, including incorrect removal and installation of the SRS, can lead to personal injury caused by unintentional activation of the system. For removal of Spiral Cable and Air Bag Module, see "SRS AIR BAG".**
- **Never use electrical test equipment on any circuit related to the SRS unless instructed to in this Service Manual. SRS wiring harnesses can be identified by yellow and/or orange harnesses or harness connectors.**

#### PRECAUTIONS WHEN USING POWER TOOLS (AIR OR ELECTRIC) AND HAMMERS

#### **WARNING:**

**Always observe the following items for preventing accidental activation.**

- **When working near the Air Bag Diagnosis Sensor Unit or other Air Bag System sensors with the ignition ON or engine running, never use air or electric power tools or strike near the sensor(s) with a hammer. Heavy vibration could activate the sensor(s) and deploy the air bag(s), possibly causing serious injury.**
- **When using air or electric power tools or hammers, always switch the ignition OFF, disconnect the battery, and wait at least 3 minutes before performing any service.**

#### Precaution for Battery Service

INFOID:000000008165026

Before disconnecting the battery, lower both the driver and passenger windows. This will prevent any interference between the window edge and the vehicle when the door is opened/closed. During normal operation, the window slightly raises and lowers automatically to prevent any window to vehicle interference. The automatic window function will not work with the battery disconnected.

# PREPARATION

< PREPARATION >

## PREPARATION

### PREPARATION

#### Commercial Service Tools

INFOID:000000008778743

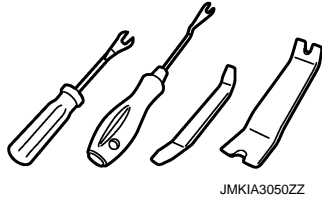
Tool name	Description
Remover tool  JMKIA3050ZZ	Removes the clips, pawls and metal clips

A  
B  
C  
D  
E  
F  
G  
H  
I  
J  
L  
M  
N  
O  
P

PWC

# POWER WINDOW MAIN SWITCH

< REMOVAL AND INSTALLATION >

## REMOVAL AND INSTALLATION

### POWER WINDOW MAIN SWITCH

#### Removal and Installation

INFOID:000000008165027

#### REMOVAL

1. Remove the door finisher.  
Refer to [INT-12, "Removal and Installation"](#).
2. Power window main switch (1) is removed from door finisher using remover tool (A).

 : Pawl

#### CAUTION:

**Do not fold the pawl of power window main switch finisher.**

#### NOTE:

The same procedure is also performed for power window sub-switch.

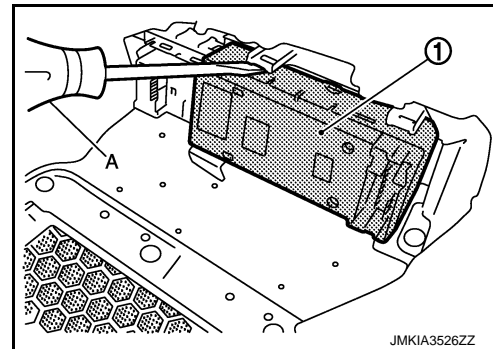

#### INSTALLATION

Install in the reverse order of removal.

#### NOTE:

Power window main switch is exchanged or is detached it is necessary to do the initialization procedure. Refer to [PWC-6, "ADDITIONAL SERVICE WHEN REPLACING CONTROL UNIT : Special Repair Requirement"](#).